



# PREISLISTE SPENGLEREIBEDARF



**PLÄTTLI  
GANZ**

BAUMATERIAL  
KERAMIK  
GEBÄUDEHÜLLE

DAS FAMILIENUNTERNEHMEN MIT TRADITION SEIT 1898

AUSGABE 2020



In unserem Marktgebiet bedienen wir Sie täglich mit unserer Logistikflotte und per Post-Versand.

**24 STUNDEN LIEFERSERVICE  
HEUTE BIS 15.15 UHR BESTELT-  
MORGEN GELIEFERT**

UNSER VERKAUFSTEAM  
IST FÜR SIE DA!

**Montag bis  
Donnerstag**  
07.00 bis 12.00 Uhr  
13.00 bis 17.00 Uhr

**Freitag**  
07.00 bis 12.00 Uhr  
13.00 bis 16.00 Uhr

**Kontakt**  
Plättli Ganz AG  
Simonstrasse 10  
9016 St.Gallen

Telefon 071 282 85 10  
Mail [info@plaetli-ganz.ch](mailto:info@plaetli-ganz.ch)  
Web [plaetli-ganz.ch](http://plaetli-ganz.ch)

Alle Preise sind Richtpreise in CHF und ohne MWST angegeben. Preisänderungen bleiben jederzeit vorbehalten. Sämtliche Angaben in der vorliegenden Dokumentation sind ohne Gewähr. Es gelten unsere allgemeinen Geschäfts-, Verkaufs- und Lieferbedingungen.  
**plaetli-ganz.ch**  
Januar 2020

1	Absturzsicherungen	<b>1</b>
2	Flüssigkunststoff / Resitrix	<b>2</b>
3	Flachdach Bauder Dichten und Dämmen / Velux / Terrassen Feinsteinzeug 2 cm / Stelzlager und Zubehör	<b>3</b>
4	Spenglerei Bleche / Aluminum / AluColor / Prefa	<b>4</b>
5	Spenglerei-Halbfabrikate Flachdach und Zubehör	<b>5</b>
6	Spenglerei-Halbfabrikate Dachrinnen und Zubehör	<b>6</b>
7	Spenglerei-Halbfabrikate Ablaufrohre und Zubehör	<b>7</b>
8	Spenglerei-Halbfabrikate Steildach und Zubehör	<b>8</b>
9	Spenglerei-Dachaustritte / Hüte / Ventilations-Hauben	<b>9</b>
10	Blitzschutz	<b>10</b>
11	Blechfertigung / Scharen / Profile / Ornamente	<b>11</b>
12	Werkzeuge / Maschinen / Löten / Dichten / Befestigen / Kleben	<b>12</b>





## SERVICE VOM FACHMANN: PLANUNG IHRER ABSTURZSICHERUNG

Ob Metaldach, Steildach, Flachdach mit oder ohne Dachdurchdringung, ob Holz, Beton, Spannbeton, Trapezblech, Sandwichpaneele, Stahl oder Blech – gerne liefern wir Ihre Aufträge in den jeweiligen Optionen direkt auf die Baustelle «Just in Time».

Rufen Sie uns bei ihrem nächsten Projekt an. Wir erarbeiten Ihnen ein zugeschnittenes Angebot.

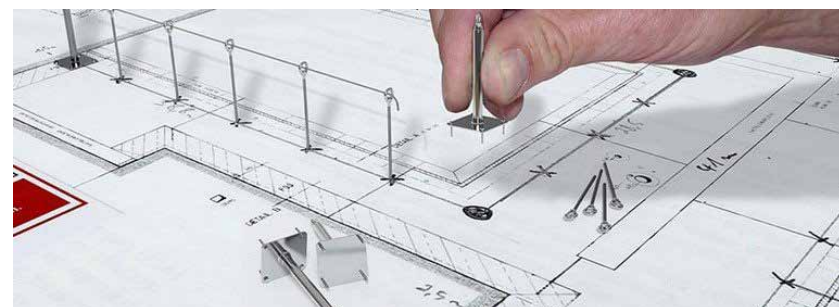

### Anschlagpunkte Flachdach Beton

#### ABS Lock III-BE



- o Edelstahl-Verankerungspunkt zum Einschlagen
- o Verwendbar als Einzelanschlagpunkt und Zwischenstütze
- o Montageaufwand unter 2 Minuten

Typ	Nettopreis
L3-BE-300	77.00
L3-BE-400	77.00
L3-BE-500	77.00
L3-BE-600	77.00
L3-BE-xxx	auf Anfrage

#### ABS Lock III-BE



- o Edelstahl-Verankerungspunkt zum Einkleben
- o Verwendbar als Einzelanschlagpunkt, Zwischenstütze und als End- und Eckhalter für Seilssysteme mit ABS Stützrohr
- o Verwendbar für Dachflächen, Wand, Fassade und Überkopf

Typ	Preis
L3-B-0-100	64.38
L3-B-300-80	89.54
L3-B-500-80	97.68
L3-B-XXX-80	auf Anfrage

#### ABS Lock X-SR (Einschlagsdübel)



- o Edelstahl-Verankerungspunkt, verstärkt  $\varnothing$  42 mm
- o Verwendbar als Einzelanschlagpunkt und als End- und Eckhalter für Seilssysteme

Typ	Preis
LX-SR-B-300	133.20
LX-SR-B-400	133.20
LX-SR-B-500	133.20
LX-SR-B-600	133.20
LX-SR-B-XXX	auf Anfrage

## Anschlagpunkte Flachdach Holz

### ABS Lock III-H



- o Edelstahl-Verankerungspunkt für Holzbalken
- o Verwendbar als Einzelanschlagpunkt und Zwischenstütze
- o zum Einschrauben in den Sparren

Typ	Preis
L3-H-300	87.32
L3-H-500	104.34
L3-H-XXX	auf Anfrage

### ABS Lock X-H-4



- o Edelstahl-Verankerungspunkt für Holzbalken
- o Verwendbar als Einzelanschlagpunkt, Zwischenstütze und als End- und Eckhalter für Seilsysteme mit ABS Stückrohr

Typ	Preis
LX-H-300-4	128.02
LX-H-500-4	134.68
LX-H-XXX-4	auf Anfrage

### ABS Lock X-H-16



- o Edelstahl-Verankerungspunkt für Holzschalung
- o Verwendbar als Einzelanschlagpunkt, Zwischenstütze und als End- und Eckhalter für Seilsysteme mit ABS Stückrohr

Typ	Preis
LX-H-300-16	159.10
LX-H-500-16	164.28
LX-H-XXX-16	auf Anfrage

2019 / 11

## Eindichtsets und Thermohauben Flachdach

### ABS Thermoschutzhauben



- o Für L-X -SR mit flachem Deckel und Loch (für Seilsystem)
- o F = für Stützen D 16 mm
- o A+F = für Stützen D 42 mm

Typ	Preis
ZU-1009F	22.20
ZU-1009A+F	31.82

### Universaleinfassungen mit Schrumpfschlauch



- o Bitumen beschiefert D 20 mm / Höhe 300 mm
- o Bitumen beschiefert D 50 mm / Höhe 300 mm

Typ	Preis
317.000.001	30.00
317.000.002	58.00

2019 / 11



## Anschlagpunkte Trapezblechdach

### ABS Lock X-T



- o Edelstahl-Anschlagpunkt für Trapezbleche
- o Ab Stahlblech-Dicke 0.63 mm
- o Lochabstand 180 - 250 mm
- o Verwendbar als Einzelanschlagpunkt, Zwischenstütze und als End- und Eckhalter für Seilssysteme mit ABS Stützrohr

Typ	Preis
LX-T-300	130.98
LX-T-400	133.20
LX-T-XXX	auf Anfrage

### ABS Lock X-SW



- o Edelstahl-Anschlagpunkt für Sandwich- und Trapezbleche
- o Ab Stahlblech-Dicke 0.5 mm
- o Lochabstand 280 - 333 mm
- o Verwendbar als Einzelanschlagpunkt, Zwischenstütze und als End- und Eckhalter für Seilssysteme mit ABS Stützrohr

Typ	Preis
LX-SW-300	139.12
LX-SW-400	139.12

### ABS Lock X-T-Alu



- o Edelstahl-Anschlagpunkt für Aluminium-Sandwichbleche
- o Ab Aluminiumblechdicke 0.8 mm
- o Lochabstand 335 mm (Grundplatte nach Mass erhältlich)
- o Verwendbar als Einzelanschlagpunkt, Zwischenstütze und als End- und Eckhalter für Seilssysteme mit ABS Stützrohr

Typ	Preis
LX-T-300-AL	248.64

### ABS Lock X-Rivet



- o Edelstahl-Anschlagpunkt für Sandwich- und Trapezbleche
- o Ab Stahlblech-Dicke 0.45 mm
- o Lochabstand 180 - 250 mm und 280 - 333 mm
- o Weitere Elemente auf Anfrage erhältlich (Seilssystem)

Typ	Preis
LX-SW-N-250	136.16
LX-SW-N-333	136.16

## Anschlagpunkte Steildach

### ABS Lock X-First II



- o Edelstahl-Anschlagpunkt für Dachfirst mit variabler Grundplatte
- o Verwendbar als Einzelanschlagpunkt, Zwischenstütze und als End- und Eckhalter für Seilssysteme mit ABS Stützrohr

Typ	Preis
LX-F12-300	165.76
LX-F12-400	167.76

### ABS Lock-DH05



- o Edelstahl-Sicherheitsdachhaken auf Sparren
- o Grundplatte für variable Montage
- o Verwendbar als Einzelanschlagpunkt und Dachleiterhaken

Typ	Preis
DH05	76.00

### ABS Lock DH04 gerade



- o Edelstahl-Sicherheitsdachhaken auf Sparren
- o Verwendbar als Einzelanschlagpunkt und Dachleiterhaken

Typ	Preis
DH04-VA-F	42.00

### ABS Lock DH04 gekröpft



- o Edelstahl-Sicherheitsdachhaken auf Sparren
- o Verwendbar als Einzelanschlagpunkt und Dachleiterhaken
- OG = blank, OG-R = rot R3009, OG-A = anthrazit R7016

Typ	Preis
DH04-VA-OG	42.00
DH04-VA-OG-R	54.00
DH04-VA-OG-A	54.00

### ABS Lock Loop



- o Edelstahl-Anschlagsschleufe auf Sparren
- o Verwendbar als Einzelanschlagpunkt

Typ	Preis
L-LOOP	57.72

## Anschlagpunkte Falzdach

### ABS Lock Falz IV Stehfalz

	Typ	Preis
 <ul style="list-style-type: none"> <li>o Edelstahl-Anschlagpunkt mit Klemmen</li> <li>o Verwendbar als Einzelanschlagpunkt und als End- und Eckhalter für Seilssysteme</li> <li>o Für Falzabstände 300-450 mm und 420-660 mm</li> <li>o CU = Kupfer, ST= graue Metalle</li> </ul>	PF-4-CU-450	359.64
	PF-4-CU-660	359.64
	PF-4-ST-450	298.96
	PF-4-ST-660	298.96

### ABS Lock Falz IV Stehfalz ZW

	Typ	Preis
 <ul style="list-style-type: none"> <li>o Edelstahl-Zwischenhalter mit Klemmen</li> <li>o Nur als Zwischenhalter verwendbar</li> <li>o CU = Kupfer, ST= graue Metalle</li> </ul>	PF-4-CU-ZW	239.02
	PF-4-ST-ZW	177.60

### ABS Lock Falz V Stehfalz

	Typ	Preis
 <ul style="list-style-type: none"> <li>o Edelstahl-Anschlagpunkt mit Klemmen</li> <li>o Verwendbar als Einzelanschlagpunkt</li> <li>o CU = Kupfer, ST= graue Metalle</li> </ul>	PF-5-CU	239.02
	PF-5-ST	177.60

### ABS Lock DH06 zum Klemmen

	Typ	Preis
 <ul style="list-style-type: none"> <li>o Edelstahl-Sicherheitsdachhaken für Metallfalzdächer</li> <li>o Durchdringungsfrei</li> <li>o Verwendbar als Einzelanschlagpunkt und Dachleiterhaken</li> </ul>	DH06	107.30

2019 / 11

## Anschlagpunkte Falzdach

### ABS Lock Falz IV Rundbördelfalz

	Typ	Preis
 <ul style="list-style-type: none"> <li>o Edelstahl-Anschlagpunkt mit Klemmen</li> <li>o Verwendbar als Einzelanschlagpunkt und als End- und Eckhalter für Seilssysteme</li> <li>o Für Falzabstände 300-450 mm und 420-660 mm</li> </ul>	PF-4RB-450	298.22
	PF-4RB-660	298.22

### ABS Lock Falz IV ZW

	Typ	Preis
 <ul style="list-style-type: none"> <li>o Edelstahl-Zwischenhalter mit Klemmen</li> <li>o Nur als Zwischenhalter verwendbar</li> </ul>	PF-5-RB-ZW	177.60

### ABS Lock Falz V Rundbördelfalz

	Typ	Preis
 <ul style="list-style-type: none"> <li>o Edelstahl-Anschlagpunkt mit Klemmen</li> <li>o Verwendbar als Einzelanschlagpunkt</li> </ul>	PF-5-RB	177.60

### ABS Lock Falz III Rundbördelfalz

	Typ	Preis
 <ul style="list-style-type: none"> <li>o Edelstahl-Anschlagpunkt mit Klemme</li> <li>o Verwendbar als Einzelanschlagpunkt für 1 Person</li> </ul>	PF-1003A	104.34

2019 / 11



## Anschlagpunkte mit Auflast und für Faserzement

### DIADEM DiaSafe Single System

	Typ	Preis
 <ul style="list-style-type: none"> <li>o Für Flachdächer Auflastgehalten</li> <li>o Durchdringungsfrei</li> <li>o Einzelanschlagpunkt</li> </ul>	130097	365.00

### ABS Weight OnTop

	Typ	Preis
 <ul style="list-style-type: none"> <li>o Für Flachdächer Auflastgehalten</li> <li>o Verwendbar als Einzelanschlagpunkt und Zwischenhalter</li> <li>o Lieferung ohne Betonplatten (8 Stück 50 x 50 x 5 cm)</li> </ul>	W-OT	654.90

### ABS Weight OnTop Double

	Typ	Preis
 <ul style="list-style-type: none"> <li>o Für Flachdächer Auflastgehalten</li> <li>o Verwendbar als Einzelanschlagpunkt, Zwischenstütze und als End- + Eckhalter für Seilsysteme mit ABS Stützrohr</li> <li>o Lieferung ohne Betonplatten (16 Stück 50 x 50 x 5 cm)</li> </ul>	W-OT-D	736.30

### ABS Lock Wave

	Typ	Preis
 <ul style="list-style-type: none"> <li>o Für Wellplatten-Dächer (Wellenabstand 177 mm)</li> </ul>	L-Wave-100	128.02
<ul style="list-style-type: none"> <li>o Auf einem Holzsparren (min.100 x 120 mm) verschraubt</li> <li>o ZH = Zwischenhalter</li> </ul>	L-Wave-100-ZH	135.42

### ABS Lock Wave 60

	Typ	Preis
 <ul style="list-style-type: none"> <li>o Für Wellplatten-Dächer (Wellenabstand 177 mm)</li> </ul>	L-Wave-60	220.52
<ul style="list-style-type: none"> <li>o Auf zwei Holzsparren (min. 60 x 120 mm) verschraubt</li> <li>o ZH = Zwischenhalter</li> </ul>	L-Wave-60-ZH	227.92

2019 / 11

## Seilsystem

### ABS Edelstahlseil 6 mm

	Typ	Preis
 <ul style="list-style-type: none"> <li>o Zu Seilsystemen ABS-Lock SYS III und IV</li> <li>o Gewicht: 152 g/m</li> <li>o Zuschnitte bis 80 m in Schnitten à 5 m</li> <li>o Zuschnitte ab 80 m in Schnitten à 10 m</li> <li>o ab 80 m werden 2 Spannelemente benötigt</li> </ul>	SY-1000A	5.99/m

### ABS Spannelement 6 mm

	Typ	Preis
 <ul style="list-style-type: none"> <li>o Edelstahl-Spannelement aus robustem V4A-Stahl</li> </ul>	SY-1007A	242.72

### ABS Gabelkopf 6 mm (eingepresst)

	Typ	Preis
 <ul style="list-style-type: none"> <li>o Edelstahl-Endelement aus robustem V4A-Stahl</li> <li>o Wird mit Seil (in bestellter Länge) eingepresst geliefert</li> </ul>	SY-1051A	69.56

### ABS TI-Bracket 6 mm

	Typ	Preis
 <ul style="list-style-type: none"> <li>o Edelstahl-Zwischenhalter für überfahrbares Seilsystem</li> </ul>	SY-TIB-6	51.80

### ABS TI-FlexCurve 6 mm

	Typ	Preis
 <ul style="list-style-type: none"> <li>o Flexibles Edelstahl-Kurvenelement für überfahrbares Seilsystem</li> </ul>	SY-TIFC-6	167.24

### ABS SolideCurve Eckumlenkrolle

	Typ	Preis
 <ul style="list-style-type: none"> <li>o Umlenkrolle aus robustem V4A-Stahl</li> <li>o Für nicht überfahrbare Seilsicherungssysteme ABS Lock SYS III (6 mm + 8 mm)</li> </ul>	SY-SC	59.20

### ABS SP

	Typ	Preis
 <ul style="list-style-type: none"> <li>o Edelstahl-Verbindungsflasche aus robustem V4A-Stahl</li> </ul>	SY-1031	80.66

2019 / 11

**Seilsystem**

**ABS Systemschild**

	Typ	Preis
 <ul style="list-style-type: none"> <li>o Aluminiumschild gewinkelte Form für Montage an Systemstützen</li> <li>o Aluminiumschild flache Form zum Befestigen an Seil oder an der Wand ( F )</li> </ul>	SY-1009	28.12
	SY-1009 F	28.12

**ABS Kraftbegrenzer**

	Typ	Preis
 <ul style="list-style-type: none"> <li>o Edelstahl-Kraftbegrenzer aus besonderem robustem V4A-Stahl</li> <li>o Mit Fallindikator für max 10 kN bei 4 Personen inkl. Kettenglied</li> </ul>	SY-FL	113.96

**ABS ProSlide für 6 + 8 mm Seile**

	Typ	Preis
 <ul style="list-style-type: none"> <li>o Abnehmbarer Seilgleiter aus Aluminium</li> <li>o für überfahrbare Seilsicherungssysteme</li> <li>o Schliesst automatisch, Sichert 1 Person gemäss Din EN 795:2012, C</li> </ul>	SY-ProSlide	279.72

**ABS Stützrohr für ABS-Lock III ST ø 42 mm**

	Typ	Preis
 <ul style="list-style-type: none"> <li>o Edelstahl-Verstärkungsrohr zu Lock III ST Anschlagpunkten</li> <li>o Erforderlich bei End- und Eckhaltern für Seilsysteme</li> </ul>	L3-Stuetzr-XXX	53.28

**ABS Stützrohr für ABS-Lock X ø 42 mm**

	Typ	Preis
 <ul style="list-style-type: none"> <li>o Edelstahl-Verstärkungsrohr für ABS-Lock X Anschlagpunkten</li> <li>o Erforderlich bei End- und Eckhaltern für Seilsysteme</li> </ul>	LX-Stuetzr-XXX	53.28

**ABS Stützrohr für ABS Weight OnTop Double ø 42 mm**

	Typ	Preis
 <ul style="list-style-type: none"> <li>o Edelstahl-Verstärkungsrohr zu W-OT Anschlagpunkten</li> <li>o Erforderlich bei End- und Eckhaltern für Seilsysteme</li> </ul>	W-OT-Stuetzr-300	53.28

**Persönliche Schutzausrüstung PSAgA**

**ABS PSA-Set für Dachdecker**

	Typ	Preis
 <ul style="list-style-type: none"> <li>o PSAgA Set mit Gurt, Verbindungsmittel und Seilkürzer, Falldämpfer und Tragtasche</li> <li>o In verschiedenen Seillängen erhältlich</li> </ul>	DD-Set-5	331.00
	DD-Set-10	347.00
	DD-Set-15	369.00
	DD-Set-20	461.00

**ABS CLICK-IT**

	Typ	Preis
 <ul style="list-style-type: none"> <li>o Y-Verbindungsmittel für diverse Anwendungen</li> </ul>	PS-CLICK-IT-1.2	675.00

**ABS Temporäres-Seil für 4 Personen 15-30m**

	Typ	Preis
 <ul style="list-style-type: none"> <li>o In verschiedenen Längen</li> <li>o Mit Seilspanner und 1,2 oder 3 freilaufenden Karabinern (je nach Länge)</li> </ul>	PS-1013-15	262.00
	PS-1013-23	310.00
	PS-1013-30	346.00

**ABS B-Lock Höhensicherungsgerät**

	Typ	Preis
 <ul style="list-style-type: none"> <li>o Höhensicherungsgerät</li> <li>o Mit Gurtband und Wirbelaufhängung</li> </ul>	PS-BL-B-2	193.00
	PS-BL-B-6	316.00
	PS-BL-B-12	499.00

**SPD Fallstopp Beutel komplett**

	Typ	Preis
 <ul style="list-style-type: none"> <li>o Fallstopp Beutel komplett, Absturz-Sicherung Auffanggurt, mitlaufendes Auffang-Gerät an beweglicher Führung, 15 Meter Kernmantel-Seil mit integriertem Falldämpfer</li> </ul>	Nr. 10008344	258.10



**Zubehör**

**ABS Care+ Aufbewahrungsschrank**



o Metallschrank rot lackiert (650 x 400 x 350 mm)

Typ	Preis
PS-1015	214.00

**ABS Drahtseilschere**



o Ratschenübersetzte Einhand-Drahtseilschere

Typ	Preis
	412.50

**ABS Verbundmörtel**



- o 2-Komponenten-Kleber für Beton und Mauerwerksmontage
- o Inklusive Mischdüsen
- o 330ml für handelsübliche Pressen (ca. 10 Löcher)

Typ	Preis
ZU-1017	39.22

**ABS Ladd-Fix**



o Leiterfixierung zur Fixmontage an Dachrinne

Typ	Preis
LF-FIX-D	151.70

**ABS Ladd-Quick**



- o Temporäre Leiterfixierung
- o Wird zwischen 2 Leitersprossen eingeklemmt

Typ	Preis
LF-QUICK	137.64

2019 / 11

**Geländer - Kollektivschutz für Flachdächer**

**BAUDER Geländer FD senkrecht, durch Ballast Kunststoffgewichte gehalten**

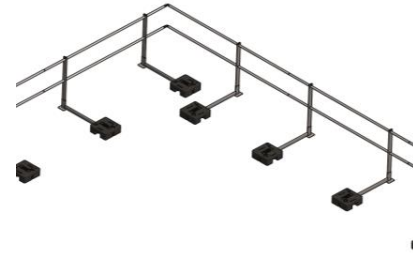

- o Material: Aluminium
- o Untergrund: Flachdach bis 10° Dachneigung
- o Neigung: senkrecht 90°
- o Pfostenabstand: max. 2 m

Preis
auf Anfrage

**BAUDER Geländer FD senkrecht, klappbar, durch Ballast Kunststoffgewichte gehalten**

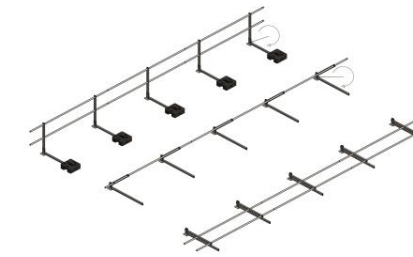

- o Material: Aluminium
- o Untergrund: Flachdach bis 10° Dachneigung
- o Neigung: senkrecht 90°, klappbar
- o Pfostenabstand: max. 2 m

Preis
auf Anfrage

**BAUDER Geländer FD 15 / FD 30, durch Ballast Kunststoffgewichte gehalten**

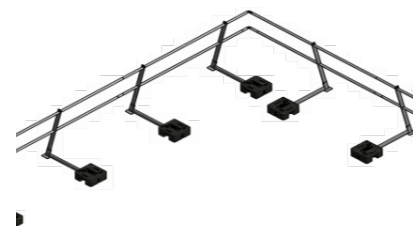

- o Material: Aluminium
- o Untergrund: Flachdach bis 10° Dachneigung
- o Neigung: FD 15 = 75° bzw. 15° nach innen geneigt
- o Neigung: FD 30 = 60° bzw. 30° nach innen geneigt
- o Pfostenabstand: max. 2 m

Preis
auf Anfrage

2019 / 11

1

Absturzicherungen

1

2

3

4

5

6

7

8

9

10

11

12

## Geländer - Kollektivschutz für Flachdächer mit Dachbegrünung

### BAUDER Geländer GD senkrecht, durch Ballast Pflanzensubstrat gehalten

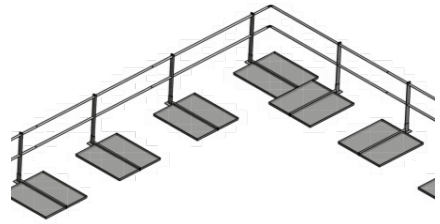

- o Material: Aluminium
- o Untergrund: Flachdach bis 10° Dachneigung
- o Neigung: senkrecht 90°
- o Pfostenabstand: max. 2 m

Preis

auf Anfrage

### BAUDER Geländer GD senkrecht, klappbar, durch Ballast Pflanzensubstrat gehalten

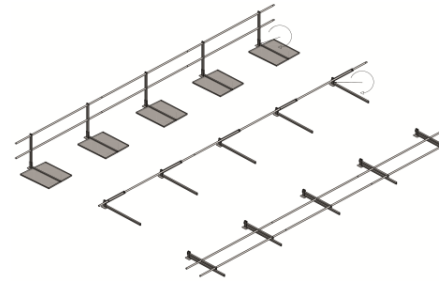

- o Material: Aluminium
- o Untergrund: Flachdach bis 10° Dachneigung
- o Neigung: senkrecht 90°, klappbar
- o Pfostenabstand: max. 2 m

Preis

auf Anfrage

### BAUDER Geländer GD 15 / GD 30, durch Ballast Pflanzensubstrat gehalten

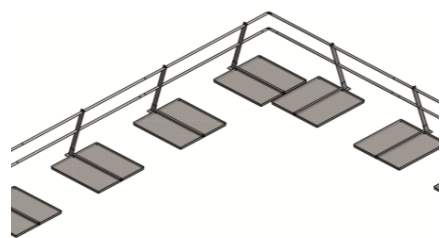

- o Material: Aluminium
- o Untergrund: Flachdach bis 10° Dachneigung
- o Neigung: GD 15 = 75° bzw. 15° nach innen geneigt
- o Neigung: GD 30 = 60° bzw. 30° nach innen geneigt
- o Pfostenabstand: max. 2 m

Preis

auf Anfrage





**375-Neu RESITRIX® SKW Dichtungsbahn 2.50 mm**



1 Rolle à 10 m <sup>2</sup> / 1 Palett = 20 Rollen		Einheit	Preis
100 cm	p. Rolle	bis 19 Rollen	282.40
100 cm	p. Rolle	ab 20 Rollen (1 Palett)	229.45

**375-Neu Zuschnittbahnen RESITRIX® SKW Dichtungsbahn 2.50 mm**

Breiten	1 Rolle à 10 m	Preis
25 cm	p. Rolle	74.24
33 cm	p. Rolle	98.96
50 cm	p. Rolle	148.48

**Zubehör zu Resitrix**



Artikel	Einheit	Preis
Flächengrundierung FG 35	4.5 kg Gb	75.24
Flächengrundierung FG 35 Sprühdose	750 ml St	30.08
Flächengrundierung FG 35 in Druckflasche	14.4 kg Gb	471.00
Spritzpistole inkl. Lanze	St	137.00
Druckschlauch für Spritzpistole	5 m St	115.00
Reiniger / Verdünner G 500	4.0 kg Gb	60.16
Stülpmanschette 5-30 mm	1 Kt à 10 St Kt	370.50

Rufen Sie uns an – wir führen das komplette Sortiment.



**ENKE Enkopur silbergrau 1K**



Eimer	à	p. St	Preis
	4,0 kg		81.70
		bis 4 Eimer	
		ab 5 Eimer	
		ab 10 Eimer	
Eimer	à 12,5 kg	p. St	220.40
		ab 22 Eimer	179.32
		ab 45 Eimer	174.84

1 Palett = 45 Eimer

**ENKE Voranstrich 1 K**

Dose	à	p. St.	Preis
	2,5 kg		32.83

**ENKE Voranstrich 2 K**

Dose	à	p. St.	Preis
	2.24 kg		55.37

**ENKE Vlies 1K PU**



Breite	10 cm	15 cm	20 cm
Rollen à 50 m p. m	0.68	0.95	1.33
Breite	26 cm	30 cm	35 cm
Rollen à 50 m p. m	1.63	1.94	2.24
			52 cm
			3.12

**ENKE Polyflex-Vlies Formteile Ecken**

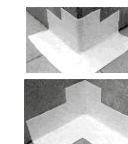

Karton à 20 Stück	/	Preis per Einzelstück
p. St.	Ecke aussen	4.29
	Ecke innen	4.29

Flüssigkunststoff / Resitrix

1  
2  
3  
4  
5  
6  
7  
8  
9  
10  
11  
12



**WestWood PMMA 2K Abdichtung Wecryl R 230 thix, 7035 grau**

			<b>bis 4 Eimer</b>	<b>ab 5 Eimer</b>	<b>ab 10 Eimer</b>
Eimer	à 10 kg	p. kg	16.95	15.96	15.58
1 Palett = 45 Eimer			<b>ab 22 Eimer</b>	<b>ab 45 Eimer</b>	
			15.20	14.44	

**WestWood Kombiprimer Wecryl 298**

Eimer	à 10 kg	p. kg	20.98
-------	---------	-------	-------

**WestWood Faserspachtel Weseal 815 grau**

Eimer	à 10 kg	p. kg	20.67
-------	---------	-------	-------

**WestWood Egalisierungsspachtel Wecryl 810 grau**

Eimer	à 10 kg	p. kg	19.23
-------	---------	-------	-------

**WestWood Metallprimer 713**

Dose	à 1 kg	p. kg	33.82
------	--------	-------	-------

**WestWood Metallprimer 714 S**

Spraydose	à 0.4 kg	p. Ds	24.97
-----------	----------	-------	-------

**WestWood Katalysator Weplus 900**

Beutel	à 0.1 kg	p. kg	44.76
--------	----------	-------	-------

**WestWood Vlies perforiert PMMA**

	<b>Breite</b>		<b>10 cm</b>	<b>15 cm</b>	<b>20 cm</b>
Rollen	à 50 m	p. m	0.76	1.03	1.29
	<b>Breite</b>		<b>26 cm</b>	<b>35 cm</b>	<b>52 cm</b>
Rollen	à 50 m	p. m	1.67	2.24	3.15

**WestWood Polyflex-Vlies Formteile Ecken**

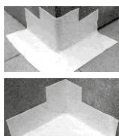
	Karton à 20 Stück	/	Preis per Einzelstück	
p. St.	Ecke aussen	4.29	Ecke innen	4.29

2019 / 11



**BAUDER Liquitec 2K PMMA, 7040 Fenstergrau**

			<b>bis 4 Eimer</b>	<b>ab 5 Eimer</b>	<b>ab 10 Eimer</b>
Eimer	à 10 kg	p. kg	16.76	15.92	15.12
1 Palett = 30 Eimer			<b>ab 22 Eimer</b>	<b>ab 30 Eimer</b>	
			14.36	13.64	

**BAUDER Fasermix, 7015 Schiefergrau**

Eimer	à 5 kg	p. kg	25.46
-------	--------	-------	-------

**BAUDER Spachtelmasse**

Eimer	à 5 kg	p. kg	22.19
-------	--------	-------	-------

**BAUDER Grundierung Detail**

Eimer	à 5 kg	p. kg	22.15
-------	--------	-------	-------

**BAUDER Katalysator**

Beutel	à 0.1 kg	p. kg	44.88
--------	----------	-------	-------

**BAUDER Metallprimer Dose**

Dose	à 1 kg	p. kg	37.22
------	--------	-------	-------

**BAUDER Metallprimer Spray**

Spraydose	p. Ds	21.96
-----------	-------	-------

**BAUDER Primer Kunststoff**

Fläschchen	à 0.4 kg	p. St.	21.93
------------	----------	--------	-------

**BAUDER Vlies perforiert PMMA**

	<b>Breite</b>		<b>10 cm</b>	<b>15 cm</b>	<b>20 cm</b>
Rollen	à 50 m	p. m	0.76	1.03	1.29
	<b>Breite</b>		<b>26 cm</b>	<b>35 cm</b>	<b>52 cm</b>
Rollen	à 50 m	p. m	1.67	2.24	3.15

**BAUDER Polyflex-Vlies Formteile Ecken**

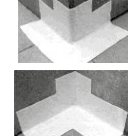
	Karton à 20 Stück	/	Preis per Einzelstück	
p. St.	Ecke aussen	4.29	Ecke innen	4.29

2019 / 11





**BAUDER Liquitec 1K PU, 7040 Fenstergrau**



		bis 14 Eimer	ab 15 Eimer	ab 25 Eimer
Eimer	à 6 kg p. kg	17.48	16.80	16.11
1 Palett = 60 Eimer			ab 40 Eimer	ab 60 Eimer
			15.47	14.86

**BAUDER Metallprimer Dose**

Dose	à 1 kg p. kg	37.22
------	--------------	-------

**BAUDER Metallprimer Spray**

Spraydose	p. Ds	21.96
-----------	-------	-------

**BAUDER Primer Kunststoff**

Fläschchen	à 0.4 kg p. St.	21.93
------------	-----------------	-------

**BAUDER Vlies 1K PU**



		10 cm	15 cm	20 cm
Breite				
Rollen	à 50 m p. m	0.68	0.95	1.33
Breite		26 cm	30 cm	35 cm
Rollen	à 50 m p. m	1.63	1.94	2.24
			52 cm	
			3.12	

**BAUDER Polyflex-Vlies Formteile Ecken**

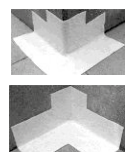

Karton à 20 Stück	/	Preis per Einzelstück	
p. St.	Ecke aussen	4.29	Ecke innen 4.29

2019 / 11



**Zubehör Flüssigkunststoff**



Artikel	Einheit	Preis
Gummihandschuhe Grösse L	Box à 50 Paar	22.04 B
Gummihandschuhe Grösse XL	Box à 45 Paar	22.04 B
Reiniger (Universal - auch für Blech)	10 Liter	12.54 L
Klebeband Beton-Gewebe gelb, Breite 5 cm	Rolle	6.46 Ro
Klebeband Maler-Feinkrepp gelb, Breite 5 cm	Rolle	3.42 Ro
Rührholz, Länge 45 cm	Karton à 25 Stück	23.18 Kt
Kunststoffeimer 5.6 Liter	Stück	2.20 St
Kunststoffeimer 12 Liter	Stück	4.33 St
Pinself 5 cm	Box à 12 Stück	1.14 St
Walzen / Rollen 5 cm	Box à 20 Stück	0.84 St
Walzen / Rollen 10 cm	Box à 10 Stück	0.84 St
Walzen / Rollen 25 cm	Stück	4.94 St
Steckbügel 5 cm	Stück	0.84 St
Steckbügel 10 cm	Stück	1.22 St
Steckbügel 25 cm	Stück	2.05 St
Vlies Schere 250 mm rostfrei	Stück	37.05 St

2019 / 11



# GERNE SIND WIR IHR BAUDER-FACHHÄNDLER

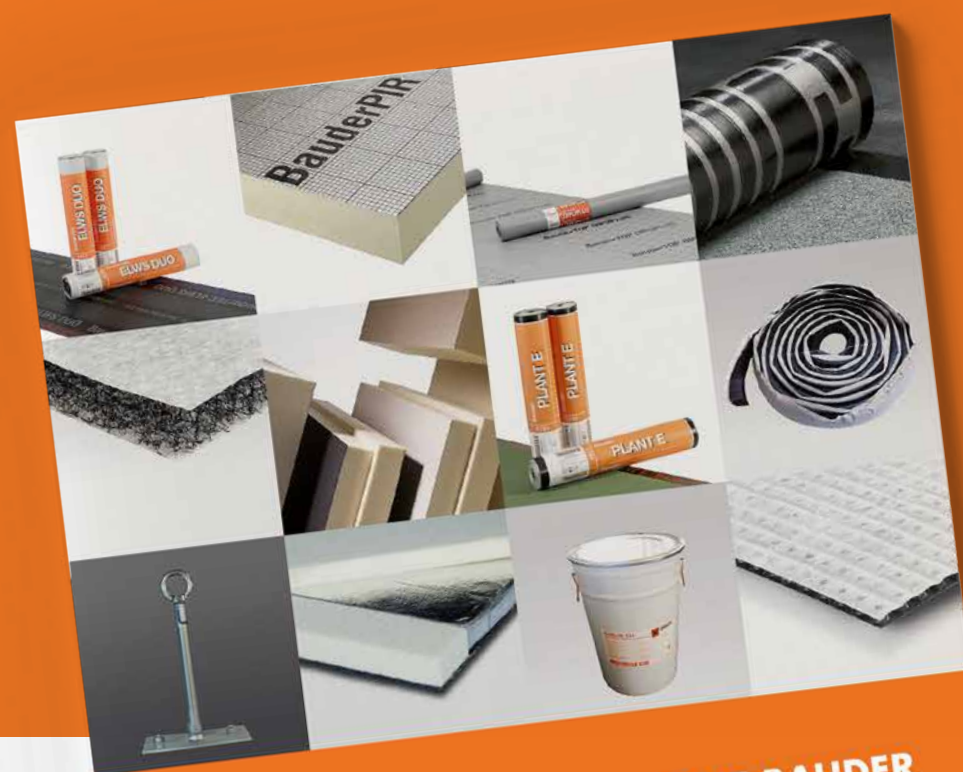

**BRUTTOPREISLISTE SORTIMENT BAUDER**  
FLACHDACH / STEILDACH / ABSTURZSICHERUNGEN

Plättli Ganz ist Ihr Bauder-Partner für Flachdach, Steildach und Absturzsicherungen.



### Produkte Wärmeleitfähigkeit

λ <sub>b</sub> [W/m·K]	Produkte
0.020	PIR Premium/PIR/MAX
0.021	PIR Novopir
0.022	PIR ALLU
0.025	PIR VILES 120-240 mm
0.026	PIR VILES 80-100 mm PIR unkaschier./Gefälleplatten ≥ 120 mm

λ <sub>b</sub> [W/m·K]	Produkte
0.027	PIR VILES 20-70 mm PIR unkaschier./Gefälleplatten 80-119 mm
0.029	LAMBDA Roof EPS grau
0.030	EPS grau Dach
0.033	EPS 30 weiss
0.034	EPS Dach 150/120 weiss
0.036	EPS 20 weiss

### U-Wert Tabelle [W/m²·K]

λ <sub>b</sub> [W/m·K]	0.020	0.021	0.022	0.023	0.024	0.025	0.026	0.027	0.028	0.029	0.030	0.031	0.032	0.033	0.034	0.035	0.036	0.037	0.038	0.039	0.040	
Dicke/mm																						
10	2,00	2,10	2,20	2,30	2,40	2,50	2,60	2,70	2,80	2,90	3,00	3,10	3,20	3,30	3,40	3,50	3,60	3,70	3,80	3,90	4,00	
20	1,05	1,05	1,10	1,15	1,20	1,25	1,30	1,35	1,40	1,45	1,50	1,55	1,60	1,65	1,70	1,75	1,80	1,85	1,90	1,95	2,00	
30	0,70	0,70	0,73	0,77	0,80	0,83	0,87	0,90	0,93	0,97	1,00	1,03	1,07	1,10	1,13	1,17	1,20	1,23	1,27	1,30	1,33	
40	0,53	0,53	0,55	0,58	0,60	0,63	0,65	0,68	0,70	0,73	0,75	0,78	0,80	0,83	0,85	0,88	0,90	0,93	0,95	0,98	1,00	
50	0,42	0,42	0,44	0,46	0,48	0,50	0,52	0,54	0,56	0,58	0,60	0,62	0,64	0,66	0,68	0,70	0,72	0,74	0,76	0,78	0,80	
60	0,35	0,35	0,37	0,38	0,40	0,42	0,43	0,45	0,47	0,48	0,50	0,52	0,53	0,55	0,57	0,58	0,60	0,62	0,63	0,65	0,67	
70	0,30	0,30	0,31	0,33	0,34	0,36	0,37	0,39	0,40	0,41	0,43	0,44	0,46	0,47	0,49	0,50	0,51	0,53	0,54	0,56	0,57	
80	0,25	0,26	0,28	0,29	0,30	0,31	0,33	0,34	0,35	0,36	0,38	0,39	0,40	0,41	0,43	0,44	0,45	0,46	0,48	0,49	0,50	
100	0,20	0,21	0,22	0,23	0,24	0,25	0,26	0,27	0,28	0,29	0,30	0,31	0,32	0,33	0,34	0,35	0,36	0,37	0,38	0,39	0,40	
120	0,17	0,18	0,18	0,19	0,20	0,21	0,22	0,23	0,23	0,24	0,25	0,26	0,27	0,28	0,28	0,29	0,30	0,31	0,32	0,33	0,33	
140	0,14	0,15	0,16	0,16	0,17	0,18	0,19	0,19	0,20	0,21	0,21	0,22	0,23	0,24	0,24	0,25	0,26	0,26	0,27	0,28	0,29	
150	0,13	0,14	0,15	0,15	0,16	0,17	0,17	0,18	0,19	0,19	0,20	0,21	0,21	0,22	0,23	0,23	0,24	0,25	0,25	0,26	0,27	
160	0,13	0,13	0,14	0,14	0,15	0,16	0,16	0,17	0,18	0,18	0,19	0,19	0,20	0,21	0,21	0,22	0,23	0,23	0,24	0,24	0,25	
180	0,11	0,12	0,12	0,13	0,13	0,14	0,14	0,15	0,16	0,16	0,17	0,17	0,18	0,18	0,19	0,19	0,20	0,21	0,21	0,22	0,22	
200	0,10	0,11	0,11	0,12	0,12	0,13	0,13	0,14	0,14	0,15	0,15	0,16	0,16	0,17	0,17	0,18	0,18	0,19	0,19	0,20	0,20	
220	0,09	0,10	0,10	0,10	0,11	0,11	0,12	0,12	0,13	0,13	0,14	0,14	0,15	0,15	0,16	0,16	0,16	0,17	0,17	0,18	0,18	
240	0,08	0,09	0,09	0,10	0,10	0,11	0,11	0,12	0,12	0,12	0,13	0,13	0,13	0,14	0,14	0,15	0,15	0,16	0,16	0,16	0,17	
250	0,08	0,08	0,09	0,09	0,10	0,10	0,10	0,11	0,11	0,12	0,12	0,12	0,13	0,13	0,14	0,14	0,14	0,15	0,15	0,16	0,16	
260	0,08	0,08	0,08	0,09	0,09	0,10	0,10	0,10	0,11	0,11	0,12	0,12	0,12	0,13	0,13	0,13	0,14	0,14	0,15	0,15	0,16	
280	0,07	0,08	0,08	0,08	0,09	0,09	0,09	0,10	0,10	0,11	0,11	0,12	0,12	0,12	0,13	0,13	0,13	0,14	0,14	0,15	0,15	
300	0,07	0,07	0,07	0,08	0,08	0,08	0,08	0,09	0,09	0,10	0,10	0,11	0,11	0,11	0,12	0,12	0,12	0,12	0,13	0,13	0,13	
320	0,07	0,07	0,07	0,07	0,08	0,08	0,08	0,08	0,09	0,09	0,09	0,10	0,10	0,10	0,11	0,11	0,11	0,12	0,12	0,12	0,13	
340	0,06	0,06	0,06	0,07	0,07	0,07	0,07	0,08	0,08	0,08	0,09	0,09	0,09	0,10	0,10	0,10	0,11	0,11	0,11	0,11	0,12	
350	0,06	0,06	0,06	0,06	0,07	0,07	0,07	0,08	0,08	0,08	0,09	0,09	0,09	0,09	0,10	0,10	0,10	0,11	0,11	0,11	0,11	
360	0,06	0,06	0,06	0,06	0,07	0,07	0,07	0,08	0,08	0,08	0,08	0,09	0,09	0,09	0,09	0,10	0,10	0,10	0,11	0,11	0,11	
380	0,06	0,06	0,06	0,06	0,06	0,07	0,07	0,07	0,08	0,08	0,08	0,08	0,09	0,09	0,09	0,09	0,09	0,10	0,10	0,10	0,11	
400	0,05	0,05	0,06	0,06	0,06	0,06	0,07	0,07	0,07	0,07	0,08	0,08	0,08	0,09	0,09	0,09	0,09	0,10	0,10	0,10	0,10	

U-Wert-Angaben beziehen sich ausschliesslich auf die Wärmedämmung.

U-Wert gemäss SIA 380/1 ≤ 0,20 [W/m²·K] Anforderung MINERGIE

≤ 0,15 [W/m²·K] Richtwert MINERGIE P

≤ 0,10 [W/m²·K]

**Dachbahnen Bauder - unser Lagersortiment:**



Typ	m2 je Rolle	m2 je Palett	Preis
Bauder EVA 35 flam	8	192	*
Bauder EGV 3 flam talk	10	200	*
Bauder EGV 3.5 vlies flam	8	192	*
Bauder EGV 3.5 flam flam	8	192	*
Bauder EP 4 WF ard flam	8	160	*
Bauder EP5 WF ard flam	8	120	*
Bauder FLEX WF 5	8	120	*
Bauder PLANT E 5.2	8	120	*
Bauder TEC KSD	10.8	259.2	*
Bauder TEC ELWS DUO	7.5	180	*
Bauder Therm UL 50	7.5	150	*
Bauder TEC KSO SN	5	140	*
Bauder EP 5 GA flam	8	120	*
Bauder BIT R 333 N-F3- nackt	20	840	*



**PIR / PUR Dämmung Bauder - unser Lagersortiment: Alu 20 bis 200 mm**



Dicke	Lambda-Wert	m2 im Paket	MAX 0.020	Vlies 0.025 - 0.027	Alu 0.020
20 mm		16.56	*	*	*
30 mm		11.52	*	*	*
40 mm		8.64	*	*	*
50 mm		7.20	*	*	*
60 mm		5.76	*	*	*
80 mm		4.32	*	*	*
100 mm		3.60	*	*	*
120 mm		2.88	*	*	*
140 mm		2.16	*	*	*
160 mm		2.16	*	*	*
180 mm		2.16	*	*	*
200 mm		1.44	*	*	*

\* Preise auf Anfrage

**Trenn-, Schutz, Drainschicht und Zubehör - unser Lagersortiment:**

Artikel	Masse	Einheit Artikel	Einheit je Palett	Preis
 10 mm, Drainage-Matte, 400 kPa unter Terrassenbeläge	2 x 15 m	30 m2 Rolle	180 m2	*
 20 mm, Schutz- Drän- und Filtermatte unter Flachdachbegrünung	1 x 50 m	50 m2 Rolle	200 m2	*
 Gummischutzmatte 6 mm	1.25 x 10 m	12.5 m2 Rolle	137.5 m2	*
 Gummischutzmatte 8 mm	1.25 x 8 m	10 m2 Rolle	110.0 m2	*
 Faserschutzmatte FSM 800 gr / 6mm	2 x 25 m	50 m2 Rolle	300 m2	*
 Filter- + Flachdachvlies 125 gr	2 x 100 m	200 m2 Rolle	2000 m2	*
 Vlies 200 gr	2 x 100 m	200 m2 Rolle	1200 m2	*
 Vlies 300 gr	2 x 60 m	120 m2 Rolle	720 m2	*
 Vlies 800 gr	2 x 25 m	50 m2 Rolle	300 m2	*
 Brandschutzlage Glasgewebe schwarz RF1	1.25 x 50 m	62.5 m2 Rolle	937.5 m2	*
 Schutzbahn FPO T/F dunkelgrau 1.2 mm	1.50 x 20 m	30 m2 Rolle	480 m2	*
 Keile-Elastomerbitumen	25 x 25 mm	25 m im Karton	900 m	*
 Voranstrich Burkolit inkl. VOC		30 Liter Eimer	420 Liter	*
 Voranstrich Q-Plus inkl. VOC		20 Liter Eimer	660 Liter	*
 Blockbitumen 85/25		ca 30 kg Block	1200 kg	*
 Ausgleichsschüttung Vermiroof		100 Liter Sack	28 Sack	*
 Eckverstärkungsrondelle DAB	16.5 cm	40 Stk im Eimer	20 Eimer	*
 TDZ-Trittschallmatte, 6 mm		112.5 m2 Rolle	4 Rollen	*

\* Preise auf Anfrage

3  
Flachdach Bauder Dichten und Dämmen / Velux / Terrassen Feinsteinzeug 2 cm / Stelzläger und Zubehör



## Speditive Direktverrechnungen über Plättli Ganz AG



## FEINSTEINZEUG-TERRASSENPLATTEN

**Unser Mutterhaus – Plättli Ganz St.Gallen – ist Pionier und führender Händler in der Schweiz rund ums Thema 2cm Feinsteinzeug.**

- Über 60 verschiedene Lagerartikel
- ca. 2400 Paletten
- Formate 60 x 60 cm, 40 x 80 cm, 60 x 90 cm und 40 x 120 cm



# ANGEBOTE GOLIATH® FÜR DACHDECKER UND SPENGLER

## Terrassenplatten Feinsteinzeug 20 mm

Gültig ab 01.02.2020

**Jetzt  
anrufen  
und Muster  
bestellen.**



**1000 49 20**  
600 x 600 x 20 mm  
Feinsteinzeug, glasiert  
grau, gewolkt,  
rektifiziert, (R11)  
23.04 m<sup>2</sup>/Palette



**1001 59 02**  
600 x 600 x 20 mm  
Feinsteinzeug, glasiert  
dunkelgrau  
rektifiziert, (R11)  
21.60 m<sup>2</sup>/Palette



**1000 41 84**  
600 x 600 x 20 mm  
Feinsteinzeug, glasiert  
hellgrau  
rektifiziert, (R11)  
21.60 m<sup>2</sup>/Palette



**1000 41 35**  
600 x 600 x 20 mm  
Feinsteinzeug, glasiert  
grau  
rektifiziert, (R11)  
21.60 m<sup>2</sup>/Palette



**1001 59 03**  
600 x 600 x 20 mm  
Feinsteinzeug, glasiert  
grau  
rektifiziert, (R11)  
21.60 m<sup>2</sup>/Palette



**1000 41 57**  
600 x 600 x 20 mm  
Feinsteinzeug, glasiert  
crème  
rektifiziert, (R11)  
21.60 m<sup>2</sup>/Palette



**1000 41 58**  
600 x 600 x 20 mm  
Feinsteinzeug, glasiert  
hellgrau-beige  
rektifiziert, (R11)  
21.60 m<sup>2</sup>/Palette



**1000 43 50**  
600 x 600 x 20 mm  
Feinsteinzeug, glasiert  
beige  
rektifiziert, (R11)  
21.60 m<sup>2</sup>/Palette



**1001 60 35**  
400 x 810 x 20 mm  
Feinsteinzeug, glasiert  
dunkelbraun  
rektifiziert, (R11)  
15.60 m<sup>2</sup>/Palette



**1001 60 34**  
400 x 810 x 20 mm  
Feinsteinzeug, glasiert  
braun  
rektifiziert, (R11)  
15.60 m<sup>2</sup>/Palette

### Preise

	600 x 600 mm	400 x 810 mm
1-5 Paletten	CHF 37.50/m <sup>2</sup>	CHF 40.50/m <sup>2</sup>
6-14 Paletten	CHF 36.50/m <sup>2</sup>	CHF 39.50/m <sup>2</sup>
ab 15 Paletten	CHF 34.50/m <sup>2</sup>	CHF 37.50/m <sup>2</sup>
ab 30 Paletten	CHF 32.50/m <sup>2</sup>	CHF 35.50/m <sup>2</sup>

## STELZLAGER GOLIATH®



Verstärkter Einstellschlüssel für millimetergenaue Einstellung

Zweikomponenten Kopf PP + Gummi, geräuscharm und rutschfest

Fugenkreuz mit Sollbruchstelle, leicht zu entfernen

Kupplungskopf hält Auflage fest auf dem Stelzlager

Gewindeschraube

Systemhalter

Wasserablauföcher

Sockel

# STELZLAGER GOLIATH®

## Massauszug für Bestellungen

### Ausmass Stelzlager zu Plattenbelägen

Plattenformat	40/40 cm	40/80 cm	40/120 cm	50/50 cm	60/60 cm	60/90 cm	30/120 cm
<b>Verlegeart Fugenbild</b>	Anzahl Stelzlager / Fugenkreuze pro m <sup>2</sup>						
<b>Kreuzfuge</b>	7.84 Stk/m <sup>2</sup>	7.84 Stk/m <sup>2</sup>	5.6 Stk/m <sup>2</sup>	4.84 Stk/m <sup>2</sup>	4.00 Stk/m <sup>2</sup>	5.2 Stk/m <sup>2</sup>	7.2 Stk/m <sup>2</sup>
<b>Halbverband</b>	14.56 Stk/m <sup>2</sup>	7.84 Stk/m <sup>2</sup>	5.6 Stk/m <sup>2</sup>	9.24 Stk/m <sup>2</sup>	7.2 Stk/m <sup>2</sup>	5.2 Stk/m <sup>2</sup>	7.2 Stk/m <sup>2</sup>

### Ausmass Schienensystem zu Plattenbelägen

Plattenformat	40/40 cm	40/80 cm	40/120 cm	50/50 cm	60/60 cm	60/90 cm	30/120 cm
<b>Verlegeart Fugenbild</b>	Meter Schienen pro m <sup>2</sup>						
<b>Kreuzfuge</b>	2.8 m/m <sup>2</sup>	2.8 m/m <sup>2</sup>	2 m/m <sup>2</sup>	2.2 m/m <sup>2</sup>	2 m/m <sup>2</sup>	2.6 m/m <sup>2</sup>	2 m/m <sup>2</sup>
<b>Halbverband</b>	5.2 m/m <sup>2</sup>	2.8 m/m <sup>2</sup>	2 m/m <sup>2</sup>	4.2 m/m <sup>2</sup>	3.6 m/m <sup>2</sup>	2.6 m/m <sup>2</sup>	2 m/m <sup>2</sup>

**pro Meter Schiene werden 2.2 Stelzlager benötigt**

Die Anzahl Fugenkreuze bei Schienensystemen kann in der oberen Tabelle entnommen werden.  
Für die benötigte Menge Schalldämmungsgummi zum Schienensystem ist die errechnete Meterzahl an Schienen zu verdoppeln.  
Für die benötigte Menge an Goliath® Spezialköpfen zur Befestigung der Schienen auf den Stelzlager zum Schienensystem zu verwenden.  
Die oben aufgeführten Mengen basieren auf einer quadratischen Referenzfläche von 5 x 5 m = 25 m<sup>2</sup> und können je nach Grösse/Form der Fläche und der Verlegeart abweichen.

# STELZLAGER GOLIATH®

## Stelzlager Goliath®

- Höhenverstellbar
- Kopf mit integriertem Antirutsch-Belag
- Fugenkreuz 4 x 12 mm mit Sollbruchstelle
- Boden 205 mm / Kopf 110 mm



Artikelnummer	Typ verstellbar von-bis	Menge / Karton	Menge / Pal.	CHF / Stück
1001 39 35	10–28 mm*	50 Stück		4.90
1001 39 32	25–40 mm	20 Stück	1320 Stück	5.60
1001 39 33	40–70 mm	20 Stück	1080 Stück	6.30
1001 39 34	60–100 mm	20 Stück	840 Stück	7.30
1001 39 30	90–160 mm	20 Stück	600 Stück	8.60
1001 39 37	150–270 mm	20 Stück	420 Stück	10.00
1001 39 41	Verlängerung 165 mm	1 Stück		4.20
1001 39 31	Höhenverstellungsschlüssel	1 Stück		56.00

\* Ø Fussplatte + Kopf 150 mm, separater Gummi

## Rabattierung Stelz-

Grundrabatt	40%
15–30 Karton	+8%
ab 31 Karton	+15%

pro Typ, nicht assortiert





## STELZLAGER GOLIATH® ZUBEHÖR



Der Clip wurde eigens entwickelt, um ein häufiges Problem von Aussenbelägen zu lösen. Der senkrechte Kanten-Clip ist ein innovatives System, mit dem sich die Stirnseite bei Treppen und Podesten fachgerecht verkleiden lässt. Das System besteht aus zwei Edelstahl-Spezialklammern, die auf dem Kopf und unter dem Fuss eingerastet werden, die Stirnplatte klemmen und mit dem nach oben gerichteten Anschlag das Verrutschen der horizontalen Kantenplatte verhindern.



Goliath® Clip für Wandabschluss

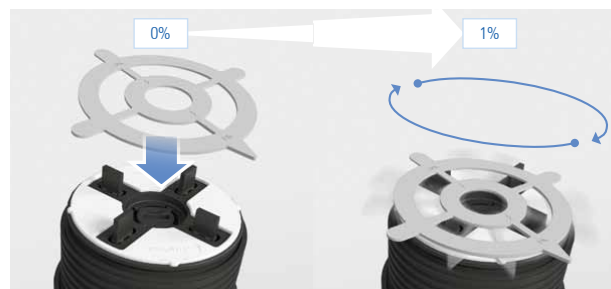

Ausgleichsscheibe bis zu 1%

	Artikelnummer	Beschreibung	CHF / Stück
	1001 39 39	Goliath® Clip Inox für Wandabschluss Höhe 25,6 mm / Länge 161,6 mm	4.40
	1001 39 40	Goliath® Ausgleichsscheibe 0% bis 1% Ø 110 mm	0.80
	1001 39 36	Goliath® Clip Inox, Teil Kopf für senkrechten Abschluss, 70 x 144 mm	10.50
	1001 39 38	Goliath® Clip Inox, Teil Boden für senkrechten Abschluss, 70 x 188 mm	10.50
	1001 59 56	Ausgleichsscheibe Gummi 3 mm	0.95



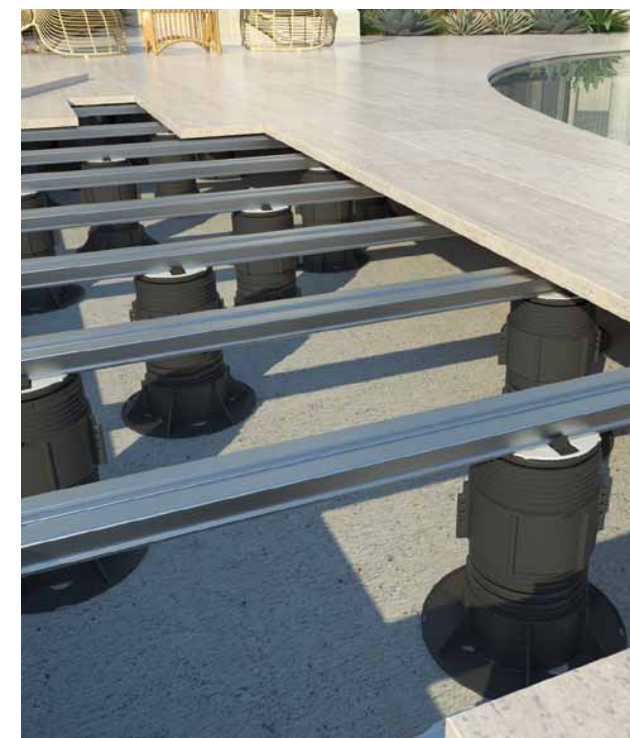

**Rabattierung  
Zubehör**

Grundrabatt 40%

## SCHIENENSYSTEM GOLIATH®

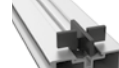









Das Verlegen auf einer Unterkonstruktion bestehend aus Aluschiene, die auf Goliath® Stelzlagern aufliegen, sorgt für hervorragende Ergebnisse in Bezug auf Sicherheit, Schnelligkeit bei der Verlegung und Stabilität der Lauffläche. Die Aluschiene wird auf dem Stelzlager-Kopf in die vorhandenen Distanzhalter eingeklinkt, das Gummiband beidseitig auf der Schiene aufgeklebt, die gewünschten Fugenkreuze eingeschoben und schon ist die Unterkonstruktion fertig für die Verlegung der Terrassenplatten.

	Artikelnummer	Beschreibung	CHF / Stück
	1001 39 42	Goliath® Schiene Aluminium B x H 60 x 25 mm / Länge 2 m	32.40
	1001 39 43	Goliath® Fugenkreuz für Schiene L x B 42 x 42 mm, Höhe 12 mm, Dicke 4 mm	0.35
	1001 39 44	Goliath® Schalldämmungsgummi für Schiene B x H 15 x 2 mm, Rolle à 10 m	19.70
	1001 39 45	Goliath® Spezialkopf für Schiene	1.60

**Rabattierung  
Zubehör**

Grundrabatt 40%

## FUGENKREUZE, FUGENPROFIL UND ZUBEHÖR

	Artikelnummer	Beschreibung	CHF
	1001 45 67	Fugenkreuz, transparent 3 mm 50 x 50 mm, Höhe 18 mm 100 Stück / Sack	25.20/Sack
	1001 57 49	Fugenkreuz, transparent 1.5 mm 50 x 50 mm, Höhe 18 mm 100 Stück / Sack	36.80/Sack
	1001 45 68	Fugenkreuz mit Teller, transparent 3 mm Ø 50 mm, Höhe 13 mm 100 Stück / Sack	25.20/Sack
	1001 65 62	Fugenkreuz mit Teller, transparent 4 mm Ø 50 mm, Höhe 13 mm 100 Stück / Sack	25.20/Sack
	1000 19 62	steifix® Netz dim. 10 Randabschlussprofil, graubeige gelocht 2 m/St	10.10/m
	1001 61 69	steifix® Fugenprofil nach Mass für geschlossene Fugen auf Splitt	5.60/m
	1001 58 56	Sarnacol 2116 Dispersionsklebstoff für die Kiesverklebung 20kg/Gb	9.90/kg
	1001 52 25 1000 84 61 1000 84 62	20 mm Fugenprofil für Terrassenplatten 30 mm im Splitt CrNi 0.80 mm, Breite 20 mm 40 mm Länge 2 Meter	7.90/m



**Kupfer, halbhart**

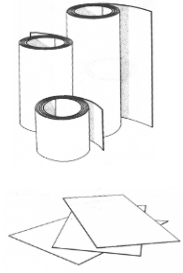

Abwicklung / Abmessung	Dicke	Rolle	Tafel	Rollen à	Rollen m1	kg / m2	Preis
200 mm	0,60 mm	x		100 kg	93	5.35	*
250 mm	0,60 mm	x		100 kg	75	5.35	*
330 mm	0,60 mm	x		100 kg	57	5.35	*
400 mm	0,60 mm	x		100 kg	47	5.35	*
500 mm	0,60 mm	x		100 kg	37	5.35	*
670 mm	0,60 mm	x		100 kg	28	5.35	*
670 mm	0,60 mm	x		500 kg	140	5.35	*
750 mm	0,60 mm	x		100 kg	25	5.35	*
1000 mm	0,60 mm	x		100 kg	19	5.35	*
1000 mm	0,60 mm	x		500 kg	94	5.35	*
1000 mm	1,00 mm	x		100 kg	11	9.00	*
1250 mm	0,60 mm	x		100 kg	15	5.35	*
670 mm	0,60 mm	x		1000 kg	279	0.35	*
1000 mm	0,60 mm	x		1000 kg	187	5.35	*
1000 x 2000 mm	0,60 mm		x			5.35	*
1000 x 2000 mm	0,80 mm		x			7.10	*

**Kupfer Tecu-Zinn**

Abwicklung / Abmessung	Dicke	Rolle	Tafel	Rollen à	Rollen m1	kg / m2	Preis
670 mm	0,60 mm	x		100 kg	28	5.35	*

**Kupfer Nordic-Brown**

Abwicklung / Abmessung	Dicke	Rolle	Tafel	Rollen à	Rollen m1	kg / m2	Preis
1000 mm	0,60 mm	x		100 kg	19	5.35	*

Weitere Qualitäten (z.B. Tecu- Oxid oder Nordic-Green) auf Anfrage



**CrNi-Stahl, Spenglerqualität, Finish 2D, matt**

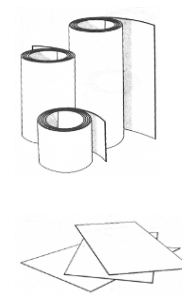

Abwicklung / Abmessung	Dicke	Rolle	Tafel	Rollen à	Rollen m1	kg / m2	Preis
200 mm	0,50 mm	x		100 kg	125	4.00	*
250 mm	0,50 mm	x		100 kg	100	4.00	*
330 mm	0,50 mm	x		100 kg	76	4.00	*
400 mm	0,50 mm	x		100 kg	63	4.00	*
500 mm	0,50 mm	x		100 kg	50	4.00	*
670 mm	0,50 mm	x		100 kg	37	4.00	*
750 mm	0,50 mm	x		100 kg	33	4.00	*
1000 mm	0,50 mm	x		100 kg	25	4.00	*
1000 mm	0,60 mm	x		100 kg	21	4.80	*
1250 mm	0,50 mm	x		100 kg	20	4.00	*
1250 mm	0,60 mm	x		100 kg	17	4.80	*
1000 mm	0,80 mm	x		100 kg	16	6.40	*
1250 mm	0,80 mm	x		100 kg	12	6.40	*
1000 mm	1,00 mm	x		100 kg	12	8.00	*
670 mm	0,50 mm	x		1000 kg	373	4.00	*
1000 mm	0,50 mm	x		1000 kg	250	4.00	*
1000 mm	0,60 mm	x		1000 kg	210	4.80	*
1250 mm	0,60 mm	x		1000 kg	170	4.80	*
1000 mm	0,80 mm	x		1000 kg	160	6.40	*
1250 mm	0,80 mm	x		1000 kg	120	6.40	*
1000 mm	1,00 mm	x		1000 kg	125	8.00	*
1000 x 2000 mm	0,50 mm		x			4.00	*
1000 x 2000 mm	0,80 mm		x			6.40	*
1000 x 2000 mm	1,00 mm		x			8.00	*

Tafeln 0.50 / 0.60 / 0.80 / 1.00 mm in verschiedenen Tafel-Formaten erhältlich, rufen Sie uns an.

1  
2  
3  
4  
5  
6  
7  
8  
9  
10  
11  
12





**Matt+ RI-Pearl**

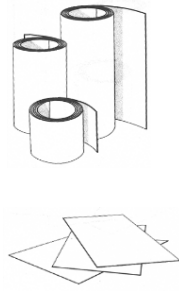

Abwicklung / Abmessung	Dicke	Rolle	Tafel	Rollen à	Rollen m1	kg / m2	Preis
200 mm	0,50 mm	x		100 kg	125	4.00	*
250 mm	0,50 mm	x		100 kg	100	4.00	*
330 mm	0,50 mm	x		100 kg	76	4.00	*
400 mm	0,50 mm	x		100 kg	63	4.00	*
500 mm	0,50 mm	x		100 kg	50	4.00	*
625 mm	0,50 mm	x		100 kg	40	4.00	*
750 mm	0,50 mm	x		100 kg	33	4.00	*
1000 mm	0,50 mm	x		100 kg	25	4.00	*
625 mm	0,50 mm	x		1000 kg	400	4.00	*
1000 mm	0,50 mm	x		1000 kg	250	4.00	*
1000 x 2000	0,50 mm		x			4.00	*

Roofinox Classic auf Anfrage

**Uginox FTE**

Abwicklung / Abmessung	Dicke	Rolle	Tafel	Rollen à	Rollen m1	kg / m2	Preis
200 mm	0,50 mm	x		100 kg	130	3.85	*
250 mm	0,50 mm	x		100 kg	104	3.85	*
330 mm	0,50 mm	x		100 kg	78	3.85	*
400 mm	0,50 mm	x		100 kg	65	3.85	*
500 mm	0,50 mm	x		100 kg	52	3.85	*
670 mm	0,50 mm	x		100 kg	39	3.85	*
750 mm	0,50 mm	x		100 kg	35	3.85	*
1000 mm	0,50 mm	x		100 kg	26	3.85	*
670 mm	0,50 mm	x		1000 kg	390	3.85	*
1000 mm	0,50 mm	x		1000 kg	260	3.85	*
1000 x 2000 mm	0,50 mm		x			3.85	*



**Rheinzink blank**

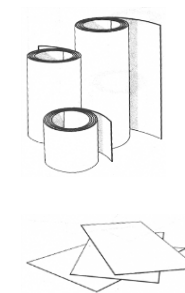

Abwicklung / Abmessung	Dicke	Rolle	Tafel	Rollen à	Rollen m1	kg / m2	Preis
200 mm	0.70 mm	x		100 kg	98	5.10	*
250 mm	0,70 mm	x		100 kg	78	5.10	*
330 mm	0,70 mm	x		100 kg	59	5.10	*
400 mm	0,70 mm	x		100 kg	49	5.10	*
500 mm	0,70 mm	x		100 kg	39	5.10	*
670 mm	0,70 mm	x		100 kg	29	5.10	*
750 mm	0,70 mm	x		100 kg	26	5.10	*
1000 mm	0,70 mm	x		100 kg	20	5.10	*
670 mm	0,70 mm	x		1000 kg	293	5.10	*
1000 mm	0,70 mm	x		1000 kg	196	5.10	*
1000 x 2000 mm	0,70 mm		x			5.10	*

**Rheinzink vorbewittert blaugrau**

Abwicklung / Abmessung	Dicke	Rolle	Tafel	Rollen à	Rollen m1	kg / m2	Preis
670 mm	0,70 mm	x		100 kg	29	5.10	*
1000 mm	0,70 mm	x		100 kg	20	5.10	*

**VM Zink Anthra**

Abwicklung / Abmessung	Dicke	Rolle	Tafel	Rollen à	Rollen m1	kg / m2	Preis
670 mm	0,70 mm	x		100 kg	29	5.10	*
1000 mm	0,70 mm	x		100 kg	20	5.10	*

Weitere Zink Abmessungen und Qualitäten (z.B. VM Quartz oder Rheinzink vorbewittert Schiefergrau) auf Anfrage

### Verzinkt, Polyester beschichtet

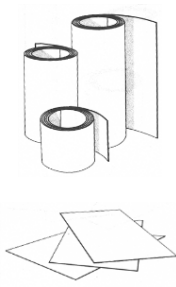

Abwicklung / Abmessung	Dicke	Rolle	Tafel	Rollen à	Rollen m1	kg / m2	Preis
auf Anfrage	0,62 mm					5.00	*
auf Anfrage	0,75 mm					6.00	*
auf Anfrage	0,87 mm					7.00	*
auf Anfrage	1,00 mm					8.00	*

\*\* Farben nach RAL / auf Anfrage \*\*



### Verzinkt, kaltgewalzt

Abwicklung / Abmessung	Dicke	Rolle	Tafel	Rollen à	Rollen m1	kg / m2	Preis
1000 mm	0,62 mm	x		100 kg	20	5.00	*
1000 x 2000 mm	0,62 mm		x			5.00	*
1000 x 2000 mm	0,87 mm		x			7.00	*

Weitere Dimensionen verzinkt auf Anfrage

### Haftblech beschichtet, beidseitig, rotbraun/grau

Abwicklung / Abmessung	Dicke	Rolle	Tafel	Rollen à	Rollen m1	kg / m2	Preis
1000 mm	0,87 mm	x		100 kg	14	7.25	*
1000 mm	0,87 mm	x		1'000 kg	140	7.25	*
1000 x 2000 mm	0,87 mm		x			7.25	*

2019 / 11

### 791-01 Acoustic Schalldämpf-Folie

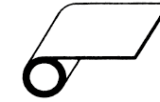

Rollen à 100 m

Breite	250 mm	330 mm
p. m.	3.40	3.95

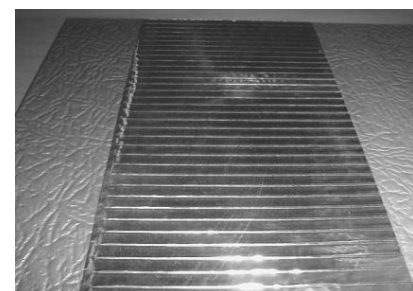
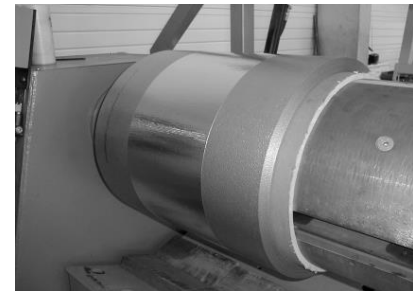

2019 / 11

**ALUColor, Aluminiumtafeln bandpulverbeschichtet**

- mit einseitiger Folie
- ab Lager lieferbar sind 7016 + 9010
- Abkantungen bis 180° möglich
- nachträglich kantbar

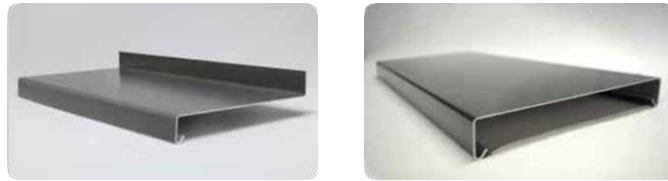

Abmessung	Dicke	Tafel	Farbe	RAL	Tafel m2	Preis
1000 x 2000 mm	1,50 mm	x	anthrazitgrau	RAL 7016	2.00	*
1000 x 2000 mm	2,00 mm	x	anthrazitgrau	RAL 7016	2.00	*
1500 x 3000 mm	1,50 mm	x	anthrazitgrau	RAL 7016	4.50	*
1500 x 3000 mm	2,00 mm	x	anthrazitgrau	RAL 7016	4.50	*
1000 x 2000 mm	1,50 mm	x	reinweiss	RAL 9010	2.00	*
1000 x 2000 mm	2,00 mm	x	reinweiss	RAL 9010	2.00	*
1500 x 3000 mm	1,50 mm	x	reinweiss	RAL 9010	4.50	*
1500 x 3000 mm	2,00 mm	x	reinweiss	RAL 9010	4.50	*

aktuelle Farben,  
Rufen Sie uns an:



**auch Rollen-Material lieferbar! Rufen Sie uns an.**

**Aluminium Tafeln**



Qualität:	Formate:	kurzfristig lieferbar in folgenden Dicken mm:			
		1000 x 2000	1250 x 2500	1500 x 3000	1500 x 4000
<b>EN AW-5005 / AIMg1</b> Normalqualität, halbhart H14/24 mit Papierzwischenlage		0.5 / 0.8 / 1.0 1.2 / 1.5 / 2.0 2.5 / 3.0 / 4.0	0.8 / 1.0 / 1.2 1.5 / 2.0 / 2.5 3.0 / 4.0	1.0 / 1.2 / 1.5 2.0 / 2.5 / 3.0 4.0	1.0 / 1.5 / 2.0 2.5 / 3.0 / 4.0
<b>EN AW-1050A / AI99.5</b> halbhart (Abkantqualität) H14/24 mit Papierzwischenlage		0.3 / 0.4 / 0.5 0.6 / 0.7 / 0.8 1.0 / 1.2 / 1.5 2.0 / 2.5 / 3.0 4.0 / 5.0 / 6.0	0.8 / 1.0 / 1.2 1.5 / 2.0 / 2.5 3.0 / 4.0 / 5.0	1.0 / 1.2 / 1.5 2.0 / 2.5 / 3.0 4.0 / 5.0 / 6.0	1.5 / 2.0 / 2.5 3.0
<b>EN AW-5005 / AIMg1</b> Normalqualität halbhart (Abkantqualität) H14/24 einseitig mit Schutzfolie 80 my		0.5 / 0.8 / 1.0 1.2 / 1.5 / 2.0 2.5 / 3.0 / 4.0 5.0 / 6.0	1.0 / 1.2 / 1.5 2.0 / 2.5 / 3.0 4.0 / 5.0	1.0 / 1.2 / 1.5 2.0 / 2.5 / 3.0 4.0 / 5.0 / 6.0	1.0 / 1.5 / 2.0 2.5 / 3.0 / 4.0
<b>EN AW-5754 / AIMg3</b> weich (Abkantqualität) H111 mit Papierzwischenlage		1.0 / 1.5 / 2.0 2.5 / 3.0 / 4.0 5.0 / 6.0 / 8.0	1.5 / 2.0 / 2.5 3.0 / 4.0 / 5.0 6.0 / 8.0	1.5 / 2.0 / 2.5 3.0 / 4.0 / 5.0 6.0 / 8.0	
<b>EN AW-5005 / AIMg1</b> Eloxalqualität halbhart (Abkantqualität) H14/24 einseitig mit Schutzfolie 80 my		0.5 / 0.8 / 1.0 1.2 / 1.5 / 2.0 2.5 / 3.0 / 4.0 5.0	1.0 / 1.2 / 1.5 2.0 / 2.5 / 3.0 4.0 / 5.0	1.0 / 1.5 / 2.0 2.5 / 3.0 / 4.0 5.0	1.5 / 2.0 / 2.5 3.0 / 4.0 / 5.0
<b>EN AW-5005 / AIMg1</b> Farblos bandeloxiert E6EV1 halbhart (Abkantqualität) H14/24 einseitig mit Schutzfolie 80 my		1.0 / 1.5 / 2.0 2.5 / 3.0	0.5 / 1.0 / 1.5 2.0 / 2.5 / 3.0	1.0 / 1.5 / 2.0 2.5 / 3.0	1.0 / 1.5 / 2.0 2.5 / 3.0

Individuelle Wünsche und Anforderungen sind ab Service-Center möglich.  
Rufen Sie uns an.





### Aluminium blank, Rollen

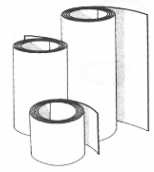

EN AW-1050 / Al99.5  
Rollen à 100 - 1000 kg  
halbhart H14/24

Abwicklung	Dicke	theor. Gewicht kg / m	Preis
1000 mm	0.60 mm	1.62	*
1000 mm	0,70 mm	1.89	*
1000 mm	0,80 mm	2.16	*
1000 mm	1,00 mm	2.70	*
1000 mm	1,20 mm	3.24	*
1000 mm	1,50 mm	4.05	*
1000 mm	2,00 mm	5.40	*
1250 mm	1,00 mm	4.22	*
1250 mm	1,50 mm	6.33	*
1500 mm	1,50 mm	9.12	*
1500 mm	2,00 mm	12.15	*

Lochbleche - Rufen Sie uns an, bzw siehe Artikel Nr. 150-69 / 150-61 /150-63 / 150-65

### Aluminium, Riffel- und Warzenbleche, Tafeln

EN AW-5754 / AlMg3  
weich (Abkantqualität) H111 / H112 / H114

	Format	Dicken
<b>Quintett</b> 	1000 x 2000 mm	2.0/3.5 - 2.5/4.0 - 3.0/4.5 - 3.5/5.0 - 4.0/5.5 - 5.0/6.5 - 7.0/8.5 - 8.0/9.5
	1250 x 2500 mm	2.0/3.5 - 2.5/4.0 - 3.0/4.5 - 3.5/5.0 - 4.0/5.5 - 5.0/6.5 - 7.0/8.5 - 8.0/9.5
	1500 x 3000 mm	2.0/3.5 - 2.5/4.0 - 3.0/4.5 - 3.5/5.0 - 4.0/5.5 - 5.0/6.5 - 7.0/8.5 - 8.0/9.5
<b>Duett</b> 	1000 x 2000 mm	1.5/2.0 - 2.5/4.0 - 3.5/5.0 - 5.0/6.5 - 8.0/9.5
	1250 x 2500 mm	1.5/2.0 - 2.5/4.0 - 3.5/5.0 - 5.0/6.5 - 8.0/9.5
	1500 x 3000 mm	1.5/2.0 - 2.5/4.0 - 3.5/5.0 - 5.0/6.5 - 8.0/9.5
<b>Reiskorn</b> 	1250 x 2500 mm	1.5/2.0 - 2.0/2.5 - 2.5/3.0
	1500 x 3000 mm	2.0/2.5

\* auf Anfrage



### PREFALZ Farbaluminium, Dicke 0,70 mm



Farbe	Code	Abwicklung	Rollen à	Rollen m1	Fläche m2	Preis
anthrazit	P 10	1000 mm	60 kg	31.74	31.74	*
anthrazit	P 10	650 mm	60 kg	48.84	31.74	*
anthrazit	P 10	500 mm	60 kg	63.49	31.74	*
braun	P 10	1000 mm	60 kg	31.74	31.74	*
braun	P 10	650 mm	60 kg	48.84	31.74	*
zinkgrau	P 10	1000 mm	60 kg	31.74	31.74	*
hellgrau	P 10	1000 mm	60 kg	31.74	31.74	*
prefaweiss	P 10	1000 mm	60 kg	31.74	31.74	*
silbermetallic	P 99	1000 mm	60 kg	31.74	31.74	*
schwarzgrau	P 99	1000 mm	60 kg	31.74	31.74	*
schwarzgrau	P 99	650 mm	60 kg	48.84	31.74	*

### FALZONAL Farbaluminium, Dicke 0,70 mm, mit Folie



Farbe	Code	Abwicklung	Rollen à	Rollen m1	Fläche m2	Preis
normreinweiss		1200 mm	120 kg	52.91	63.49	*
normreinweiss		600 mm	120 kg	105.82	63.49	*

Dieses Sortiment ist ab unserem Lager lieferbar!

Restlichen Farben und Abwicklungen, sowie Prefa Halbfabrikate etc, innert weniger Tage lieferbar!

\* auf Anfrage

Spenglerei Bleche / Aluminium / AluColor / Prefa

1  
2  
3  
4  
5  
6  
7  
8  
9  
10  
11  
12



Rufen Sie uns an. Gerne beraten wir Sie beim nächsten Objekt.

<b>DACH</b>	01	P.10 braun (Eigenfarbe)
	02	P.10 anthrazit (ähnlich RAL 7016)
	03	P.10 schwarz (ähnlich RAL 9004)
	04	P.10 ziegelrot (ähnlich RAL 8004)
	05	P.10 oxydrot (ähnlich RAL 3009)
	06	P.10 moosgrün (ähnlich RAL 6005)
	07	P.10 hellgrau (ähnlich RAL 7005)
	11	P.10 nussbraun (Eigenfarbe)
	13	naturblank
	43	P.10 steingrau (Eigenfarbe)



<b>DACHENTWÄSSERUN</b>	01	braun (Eigenfarbe)
	02	anthrazit (ähnlich RAL 7016)
	03	schwarz (ähnlich RAL 9005)
	04	ziegelrot (ähnlich RAL 8004)
	05	oxydrot (ähnlich RAL 3009)
	06	moosgrün (ähnlich RAL 6005)
	07	hellgrau (ähnlich RAL 7005)
	08	zinkgrau (Eigenfarbe)
	10	prefaweiss (ähnlich RAL 9002)
	11	nussbraun (Eigenfarbe)
12	silbermetallic (ähnlich RAL 9006)	
13	naturblank	



<b>PREFALZ</b>	01	P.10 braun (Eigenfarbe)
	02	P.10 anthrazit (ähnlich RAL 7016)
	03	P.10 schwarz (ähnlich RAL 9004)
	04	P.10 ziegelrot (ähnlich RAL 8004)
	05	P.10 oxydrot (ähnlich RAL 3009)
	06	P.10 moosgrün (ähnlich RAL 6005)
	07	P.10 hellgrau (ähnlich RAL 7005)
	08	P.10 zinkgrau (Eigenfarbe)
	10	P.10 prefaweiss (ähnlich RAL 9002)
	11	P.10 nussbraun (Eigenfarbe)
	12	silbermetallic (ähnlich RAL 9006)
	13	naturblank
	23	schwarzgrau (Eigenfarbe)
	43	P.10 steingrau (Eigenfarbe)
45	bronze (Eigenfarbe)	
46	P.10 patina grün (Eigenfarbe)	
47	patina grau (Eigenfarbe)	



<b>FASSADE</b>	01	P.10 braun (Eigenfarbe)
	02	P.10 anthrazit (ähnlich RAL 7016)
	03	P.10 schwarz (ähnlich RAL 9004)
	04	P.10 ziegelrot (ähnlich RAL 8004)
	05	P.10 oxydrot (ähnlich RAL 3009)
	06	P.10 moosgrün (ähnlich RAL 6005)
	07	P.10 hellgrau (ähnlich RAL 7005)
	10	P.10 prefaweiss (ähnlich RAL 9002)
	11	P.10 nussbraun (Eigenfarbe)
	12	silbermetallic (ähnlich RAL 9006)
	17	reinweiss (ähnlich RAL 9010)
	20	rauchsilber (ähnlich RAL 9007)
	21	rubinrot (ähnlich RAL 3003)
	23	schwarzgrau (Eigenfarbe)
	25	elfenbein (ähnlich RAL 1015)
	26	holz dunkel (Eigenfarbe)
	40	holz hell (Eigenfarbe)
41	P.10 rostbraun (Eigenfarbe)	
42	P.10 sandbraun (Eigenfarbe)	
43	P.10 steingrau (Eigenfarbe)	
45	bronze (Eigenfarbe)	
47	patina grau (Eigenfarbe)	



1  
2  
3  
4  
5  
6  
7  
8  
9  
10  
11  
12



**10016725 Dachwassereinlauf Provisorium**  
**10017372**

Kunststoff TPE, kompatibel auf Bitumenbahnen, für Beton-Dampfsperre



Einzel 1 Karton 2 - 4 Kt. 5 - 9 Kt. 10-19 Kt. 1 Palett

Typ A - für 110 / 90 mm	p. St.	11.50	7.50	6.50	6.00	5.50	4.50
-------------------------	--------	-------	------	------	------	------	------

Typ B - für 75 / 63 / 56 mm	p. St.	11.50	7.50	6.50	6.00	5.50	4.50
-----------------------------	--------	-------	------	------	------	------	------

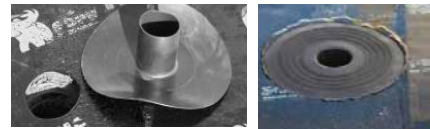

Typ A 1 Karton = 25 Stück / 1 Palett = 20 Karton  
Typ B 1 Karton = 25 Stück / 1 Palett = 25 Karton

**301-01 Dachwassereinlauf eckig mit konischem Stutzen 300 mm**

Stutzenlänge 300 mm, Konushöhe 40 mm, aufgeraut

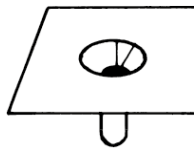

Ø Tablett	63 mm	73 mm	75 mm	80 mm	90 mm	95 mm	
400x400	400x400	400x400	400x400	400x400	400x400	400x400	
Kupfer	p. St.	46.00	61.00	46.00	61.00	46.00	61.00
Cr-Ni-Stahl		37.00	41.00	37.00	41.00	37.00	41.00

Ø Tablett	100 mm	110 mm	115 mm	125 mm	140 mm	160 mm	
400x400	400x400	400x400	500x500	500x500	500x500	500x500	
Kupfer	p. St.	66.00	46.00	53.50	53.50	-	-
Cr-Ni-Stahl		41.00	37.00	48.00	48.00	48.00	48.00

**301-01 Dachwassereinlauf eckig mit konischem Stutzen 400 mm**

Stutzenlänge 400 mm, Konushöhe 40 mm, aufgeraut

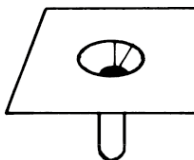

Ø Tablett	63 mm	73 mm	75 mm	80 mm	90 mm	95 mm	
400x400	400x400	400x400	400x400	400x400	400x400	400x400	
Kupfer	p. St.	50.00	65.00	50.00	65.00	50.00	65.00
Cr-Ni-Stahl		41.00	45.00	41.00	45.00	41.00	45.00

Ø Tablett	100 mm	110 mm	115 mm	125 mm	140 mm	160 mm	
400x400	500x500	500x500	500x500	500x500	500x500	500x500	
Kupfer	p. St.	70.00	50.00	58.00	58.00	-	-
Cr-Ni-Stahl		45.00	41.00	51.00	51.00	55.00	55.00

weitere Dimensionen auf Anfrage



**301-03 Dachwassereinlauf eckig mit geradem Stutzen (aufgeraut) 300 mm**

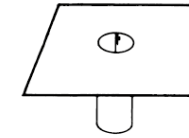

Ø Tablett	40 mm	50 mm	56 mm	63 mm	73 mm	75 mm	90 mm
300x300	300x300	300x300	300x300	400x400	400x400	400x400	400x400

Kupfer	p. St.	-	41.00	41.00	41.00	41.00	41.00
--------	--------	---	-------	-------	-------	-------	-------

Cr-Ni-Stahl		29.00	29.00	29.50	29.50	29.50	29.50
-------------	--	-------	-------	-------	-------	-------	-------

Ø Tablett	95 mm	98 mm	100 mm	110 mm	115 mm	125 mm	140 mm
400x400	400x400	400x400	400x400	500x500	500x500	500x500	500x500

Kupfer	p. St.	41.00	*	41.00	41.00	44.50	44.50	44.50
--------	--------	-------	---	-------	-------	-------	-------	-------

Cr-Ni-Stahl		29.50	29.50	29.50	29.50	32.00	32.50	37.50
-------------	--	-------	-------	-------	-------	-------	-------	-------

Ø Tablett	160 mm
500x500	

Kupfer	p. St.	47.50
--------	--------	-------

Cr-Ni-Stahl		37.50
-------------	--	-------

**301-04 Dachwassereinlauf eckig mit geradem Stutzen (aufgeraut) 400 mm**

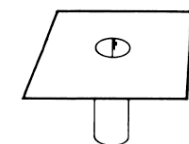

Ø Tablett	40 mm	50 mm	56 mm	63 mm	73 mm	75 mm	90 mm
300x300	300x300	300x300	300x300	400x400	400x400	400x400	400x400

Kupfer	p. St.	-	58.00	43.50	43.50	43.50	43.50	43.50
--------	--------	---	-------	-------	-------	-------	-------	-------

Cr-Ni-Stahl		37.00	32.00	32.00	32.00	32.00	32.00	32.00
-------------	--	-------	-------	-------	-------	-------	-------	-------

Ø Tablett	95 mm	98 mm	100 mm	110 mm	115 mm	125 mm	140 mm
400x400	400x400	400x400	400x400	500x500	500x500	500x500	500x500

Kupfer	p. St.	43.50	*	43.50	43.50	47.00	47.00	47.00
--------	--------	-------	---	-------	-------	-------	-------	-------

Cr-Ni-Stahl		32.00	32.00	32.00	32.00	34.50	35.00	39.50
-------------	--	-------	-------	-------	-------	-------	-------	-------

Ø Tablett	160 mm
500x500	

Kupfer	p. St.	49.50
--------	--------	-------

Cr-Ni-Stahl		39.50
-------------	--	-------

\* auf Anfrage





**301-05 Notüberlauf**

Tablett gerade, Stutzen 85°, Länge 500 mm

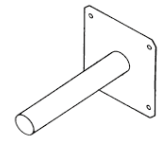

Ø Tablett	40 mm	56 mm	63 mm	73 mm
Cr-Ni-Stahl p. St.	400 x 400 48.00	400 x 400 48.00	400 x 400 48.00	400 x 400 48.00

Ø Tablett	75 mm	90 mm	95 mm	98 mm
Cr-Ni-Stahl p. St.	400 x 400 48.00	400 x 400 48.00	400 x 400 48.00	400 x 400 48.00

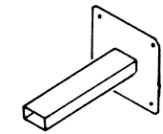

Stutzen Tablett	40x80 mm	50x80 mm	50x100 mm	50x120 mm
Cr-Ni-Stahl p. St.	400 x 400 45.50	400 x 400 45.50	400 x 400 45.50	400 x 400 45.50

Stutzen Tablett	50x150 mm	80x100 mm	80x180 mm	80x300 mm
Cr-Ni-Stahl p. St.	400 x 400 45.50	400 x 400 45.50	500 x 400 55.00	600 x 400 99.00

**301-06 Notüberlauf**

Tablett abgewinkelt, Stutzen 85°, Länge 500 mm (solange Vorrat 400 mm)

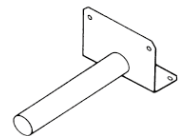

Ø Tablett	40 mm	56 mm	63 mm	73 mm
Cr-Ni-Stahl p. St.	400 x 400 48.00	400 x 400 48.00	400 x 400 48.00	400 x 400 48.00

Ø Tablett	75 mm	90 mm	95 mm	98 mm	115 mm
Cr-Ni-Stahl p. St.	400 x 400 48.00	400 x 400 48.00	400 x 400 48.00	400 x 400 48.00	400 x 400 48.00

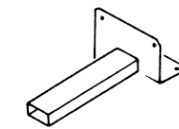

Stutzen Tablett	40x80 mm	50x80 mm	50x100 mm	50x120 mm
Cr-Ni-Stahl p. St.	400 x 400 45.50	400 x 400 45.50	400 x 400 45.50	400 x 400 45.50

Stutzen Tablett	50x150 mm	80x100mm	80x120 mm	80x180 mm	80x300 mm
Cr-Ni-Stahl p. St.	400 x 400 45.50	400 x 400 45.50	400 x 400 51.00	500 x 400 55.00	600 x 400 99.00

2019 / 11



**301-08 Ausspeier abgewinkelt, abgekröpft**

Tablett 30 mm abgekröpft für Bitumenkeil, Stutzen 85°, Länge 500 mm

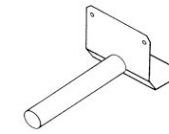

Ø Tablett	40 mm	56 mm	63 mm	73 mm
Cr-Ni-Stahl p. St.	350 x 350 82.00	360 x 360 82.00	400 x 400 82.00	400 x 400 82.00

Ø Tablett	75 mm	90 mm	95 mm	98 mm	115 mm
Cr-Ni-Stahl p. St.	400 x 400 82.00	400 x 400 82.00	400 x 400 82.00	400 x 400 88.00	400 x 400 88.00

**301-09 Tablett 30 mm abgekröpft für Bitumenkeil, Stutzen 85°, Länge 500 mm**

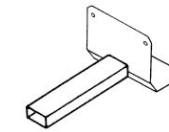

Stutzen Tablett	40x80 mm	50x50 mm	50x80 mm	50x100 mm	50x120 mm
Cr-Ni-Stahl p. St.	400 x 400 83.00	400 x 400 83.00	400 x 400 83.00	400 x 400 83.00	400 x 400 83.00

Stutzen Tablett	50x150 mm	80x100mm	80x120 mm	80x200 mm	80x300 mm
Cr-Ni-Stahl p. St.	400 x 400 83.00	400 x 400 83.00	400 x 400 98.00	400 x 400 108.00	600 x 400 108.00

2019 / 11

**301-91 Universal Rückstaudichtung für Dachwasser-Einläufe**

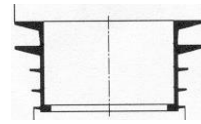
			Ø 50 mm	56 mm	63 mm	75 mm
	Kunststoff EPDM	p. Karton	41.00	41.00	41.00	41.00
				90 mm	95 mm	110 mm
	Kunststoff EPDM	p. Karton		45.00	51.00	51.00
				125 mm	140 mm	160 mm
Kunststoff EPDM	p. St.		23.00	25.00	31.00	

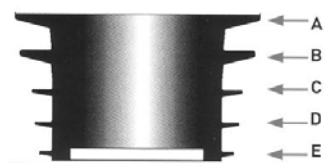

Masstabelle	Passend zu:				
	Stutzen-Ø Einlauf	Geberit	Von Roll Guss	Eternit	PVC / HT
50 mm	63, 75	60	70	75	57
56 mm	75, 90	80	70, 80	75	69
63 mm	75, 90	80	70, 80	75	69
75 mm	90, 110	100	100	110	83
90 mm	110	100	100	110	101.4
95 mm	110	100	100	110	101.4
110 mm	125	125	125	125	115.2
125 mm	150	150	150	150	147.6
140 mm	150, 200	150	150	150, 200	147.6
160 mm	200	-	-	200	187.6

Ø	Durchmesser der Dichtlippen				
	A	B	C	D	E
50 mm	77	74	66	64	61
56 mm	90	90	74	73	73
63 mm	90	90	74	73	73
75 mm	108	108	91	89	89
90 mm	111	110	108	106	105
95 mm	111	110	108	106	105
110 mm	135	133	124	122	120
125 mm	160	160	154	154	152
140 mm	200	196	156	154	152
160 mm	200	196	196	194	194

**301-95 Anschluss Kanalisation**

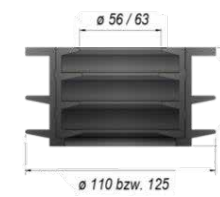
	125 PE	p. St.	17.00
---	--------	--------	-------

**302-01 Laubkorb SPD Ø 200 mm**

	Stutzen	Ø 80 - 180 mm	
	Kunststoff schwarz	p. St.	12.50

**302-01 Laubkorb mit Flügelschraube BIMAG rund**

	Stutzen bis	Ø 135 mm	
	Kunststoff schwarz	p. St.	13.50

**302-02 Laubkorb mit Flügelschraube BIMAG eckig**

	Stutzen bis	Ø 135 mm	
	Kunststoff grau	p. St.	16.80



**303-01 Asphaltrahmen**

Höhe	20 mm	110/110 mm	160/160 mm	210/210 mm	260/260 mm
verzinkt	p. St.	*	*	*	*
Cr-Ni-Stahl		21.00	21.00	21.00	23.00

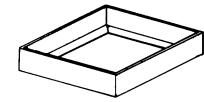

**303-01 Kiesrahmen eckig**

Höhe	40 mm	110/110 mm	160/160 mm	210/210 mm	260/260 mm
verzinkt	p. St.	*	*	*	*
Cr-Ni-Stahl		21.00	21.00	21.00	23.00

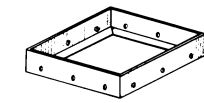

Höhe	60 mm	110/110 mm	160/160 mm	210/210 mm	260/260 mm
verzinkt	p. St.	*	*	*	*
Cr-Ni-Stahl		23.00	23.00	23.00	26.00

Höhe	80 mm	160/160 mm	210/210 mm	260/260 mm
Cr-Ni-Stahl		27.00	27.00	29.00

Höhe	100 mm	160/160 mm	210/210 mm	260/260 mm
Cr-Ni-Stahl		30.00	30.00	33.00

\* auf Anfrage



**303-04 Kiesrahmen verstellbar, Höhe 60 - 110 mm**

	110/110 mm	160/160 mm	210/210 mm	260/260 mm
Cr-Ni-Stahl	33.00	33.00	34.00	35.00

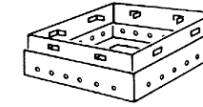

**303-08 Aufsetzrahmen eckig, Höhe 20 mm**

	100/100 mm	150/150 mm	200/200 mm	250/250 mm
Cr-Ni-Stahl	16.50	16.50	17.00	21.00

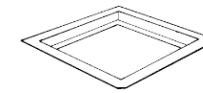

**303-09 Aufsetzrahmen verstellbar, Höhe 60 - 110 mm**

	110/110 mm	160/160 mm	210/210 mm	260/260 mm
Cr-Ni-Stahl	33.00	33.00	35.00	44.00

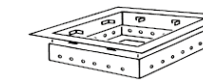

**303-21 Lochblech-Rost eckig, Rundloch 10 mm, Höhe 20 mm**

	100/100 mm	150/150 mm	200/200 mm	250/250 mm
Cr-Ni-Stahl	18.00	21.00	23.00	26.00



**303-23 Lochblech-Rost eckig, Langloch 6 x 30 mm, Höhe 20 mm**

	100/100 mm	150/150 mm	200/200 mm	250/250 mm
Cr-Ni-Stahl	p. St.	18.00	21.00	23.00
			23.00	26.00

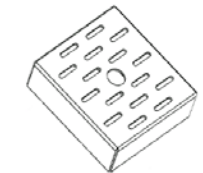

**303-26 Gitterrost eckig, Höhe 20 mm**

	100/100 mm	150/150 mm	200/200 mm	250/250 mm
Cr-Ni-Stahl	26.00	26.00	26.00	39.00

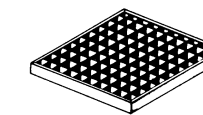



**308-01 Kontrollstutzen für Flachdach, rund**



Kontrollrohr Ø **125 mm**

Höhe 400 mm mit Isolationskern 700 mm und Deckel, Tablett 500 x 500 mm

Cr-Ni-Stahl	p. St.	98.00
-------------	--------	-------

**308-02 Kontroll-Stutzen für Flachdach, Höhe 300 mm**

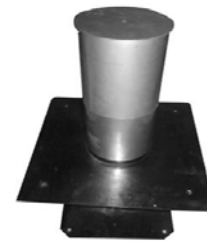

Kontrollrohr Ø **75 mm**

Cr-Ni-Stahl	p. St.	189.00
-------------	--------	--------

bestehend aus:

Tablett 300 x 300 mm, variabel für Isolation 40 - 200 mm  
Tablett 420 x 420 mm  
Kontrollrohr Ø 75 mm, 300 mm lang, isoliert 25 mm  
Abdeckhaube Ø 140 mm, 180 mm lang



**308-05 Kontroll-Stutzen eckig für Flachdach, Höhe 300 mm**

mit Isolationskern und Deckel, Tablett 425 x 425 mm

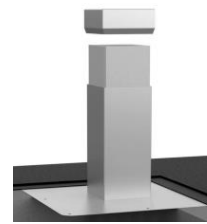

**125 x 125 mm**

Cr-Ni-Stahl 1,0 mm	p. St.	135.00
--------------------	--------	--------

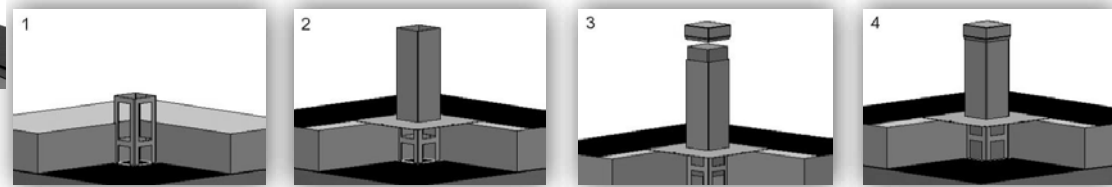

**308-05 Isolations-Korb zu Kontroll-Stutzen eckig, Höhe 250 mm**

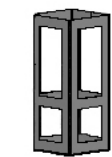

**123 x 123 mm**

Cr-Ni-Stahl 0.80 mm	p. St.	24.50
---------------------	--------	-------

2019 / 11

**310-01 Dunstrohreifassung für Flachdach**

Höhe 400 mm

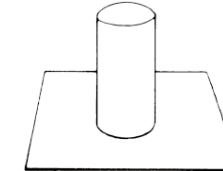

Für Geberit Ø	75 mm	90 mm	110 mm	125 mm
Rohr Ø	85 mm	110 mm	125 mm	140 mm
Tablett mm	400x400	430x430	430x430	450 x 450

Kupfer	p. St.	64.00	64.00	69.00	69.00
--------	--------	-------	-------	-------	-------

Cr-Ni-Stahl		31.50	33.00	33.00	36.00
-------------	--	-------	-------	-------	-------

Rohr Ø	148 mm	163 mm	183 mm	208 mm
Tablett mm	500x500	500x500	500x500	500x500

Cr-Ni-Stahl	p. St.	37.50	37.50	41.00	43.50
-------------	--------	-------	-------	-------	-------

weitere Dimensionen auf Anfrage !

**310-11 Dunstrohreifassung für Flachdach, komplett System**

Höhe 400 mm, inkl. Isolation und Deckel mit Dichtung aus Alu

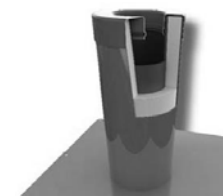

Für Geberit Ø	90 mm	110 mm
Rohr Ø	165 mm	165 mm
Tablett mm	465x465	465x465

Cr-Ni-Stahl 0,8 mm	p. St.	87.00	87.00
--------------------	--------	-------	-------

2019 / 11

**310-51 Einfassung für Kabelstränge Flachdach**



Höhe 540 mm Deckel abnehmbar

Rohe Ø 200 x 200 mm  
Tablett mm 500 x 500 mm

Cr-Ni-Stahl	p. St.	198.00
-------------	--------	--------



**310-59 Kabeldurchführung Flachdach**



Höhe 400 mm

Rohe Ø	50	84	104	124	154	204	
Tablett mm	400 x 400	400 x 400	400 x 400	500 x 500	500 x 500	500 x 500	
Cr-Ni-Stahl 2,0	p. St.	169.00	249.00	277.00	378.00	425.00	547.00

2019 / 11

**311-01 Flachdachrinne**

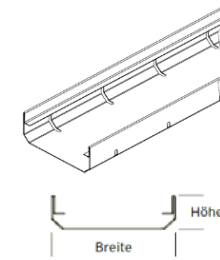

beidseitig gelocht, inkl. Verbindungsglaschen, Länge 2 m

Breite	80 mm	100 mm	100 mm	100 mm	
Höhe	40 mm	20 mm	30 mm	40 mm	
Cr-Ni-Stahl 0.8 mm	p. m.	16.10	16.10	16.10	16.10

Breite	125 mm	125 mm	125 mm	125 mm	125 mm	
Höhe	20 mm	30 mm	40 mm	50 mm	60 mm	
Cr-Ni-Stahl 0.8 mm	p. m.	16.10	16.10	16.10	16.10	16.10

Mengenstaffelungen - Fragen Sie uns an!

**311-05 Flachdachrinne höhenverstellbar**

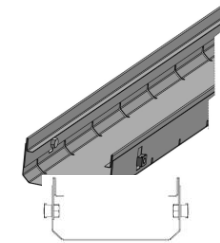

Höhe 60 - 80 mm	Länge 2 m	80 mm	100 mm	125 mm	150 mm
Cr-Ni-Stahl	p. m.	*	*	*	*

Höhe 80 - 140 mm	Länge 2 m	80 mm	100 mm	125 mm	150 mm
Cr-Ni-Stahl	p. m.	*	*	*	*

\* auf Anfrage

**311-12 Boden zu Flachdachrinne**

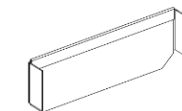

Breite	80 mm	100 mm	125 mm	125 mm	125 mm	125 mm	
Höhe	40 mm	40 mm	30 mm	40 mm	50 mm	60 mm	
Cr-Ni-Stahl	p. St.	9.50	9.50	9.50	9.50	9.50	9.50

2019 / 11

**311-13 Winkel 90°**

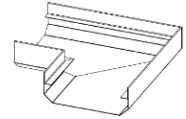
	Breite	100 mm	125 mm	125 mm	125 mm	125 mm
	Höhe	40mm	30 mm	40 mm	50 mm	60 mm
Cr-Ni-Stahl	p. St.	32.00	32.00	32.00	32.00	32.00

**311-18 Abzweiger T-Stück**

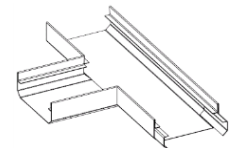
	Breite	125 mm	125 mm	125 mm
	Höhe	40 mm	50 mm	60 mm
Cr-Ni-Stahl	p. St.	37.00	37.00	37.00

**311-41 Gitterrost**

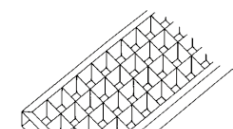
	Länge 1 m		80 mm	100 mm	125 mm
	verzinkt 1.5 mm	p. St.	*	*	*
	Cr-Ni-Stahl 2.0 mm		*	*	*

\* auf Anfrage

**311-35 Stegrost**

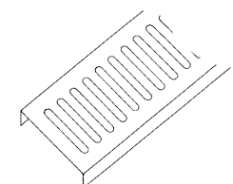
	Länge 1 m		100 mm	125 mm
	verzinkt 1.5 mm	p. St.	*	*
	Cr-Ni-Stahl 1.0 mm		17.20	17.20

2019 / 11

**311-32 Lochblechrost mit Kopfkantung**

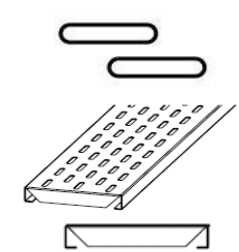
	Langloch abgerundet 30 x 6 mm Länge 1 m		80 mm	100 mm	125 mm
	Cr-Ni-Stahl 1.20 mm	p. m.	16.10	16.10	16.10

**311-34 Lochblechrost mit Kopfkantung**

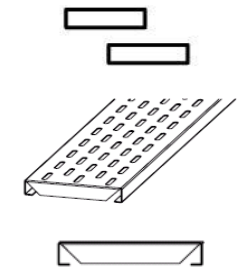
	Langloch eckig 25 x 6 mm Länge 1 m		80 mm	100 mm	125 mm
	Cr-Ni-Stahl 1.20 mm	p. m.	16.10	16.10	16.10

**311-36 Lochblechrost ohne Kopfkantung**

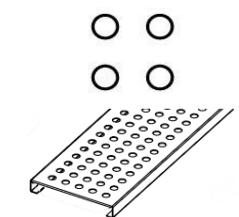
	Rundloch Ø 10 mm Länge 1 m		100 mm	125 mm
	Cr-Ni-Stahl 1.20 mm	p. m.	17.20	17.20

**311-37 Lochblechrost ohne Kopfkantung**

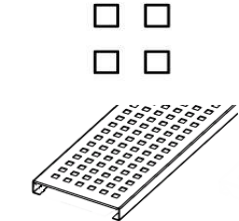
	Quadratloch 10 x 10 mm Länge 1 m		100 mm	125 mm
	Cr-Ni-Stahl 1.20 mm	p. m.	17.20	17.20

**Fugenprofil für Terrassenplatten im Splitt**

	CrNi 0.80 mm, Breite 20 mm, Länge 2 Meter				
	Höhe:		20 mm	30 mm	40 mm
		p. m.	7.90	7.90	7.90

2019 / 11



**312-01 ANTARES Lüftungshut für Flachdach**

Höhe 400 mm  
isoliert 25 mm

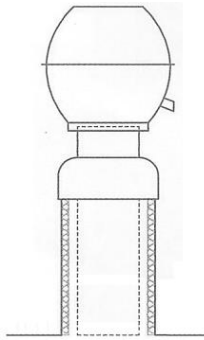



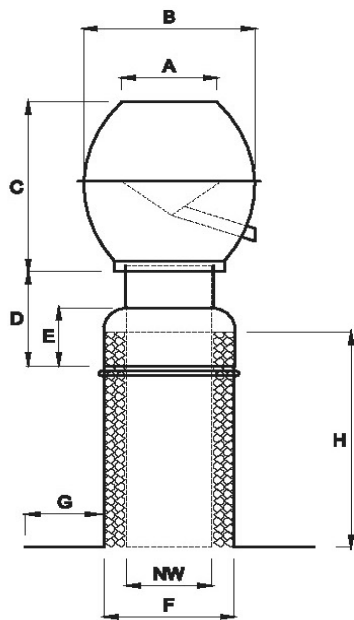
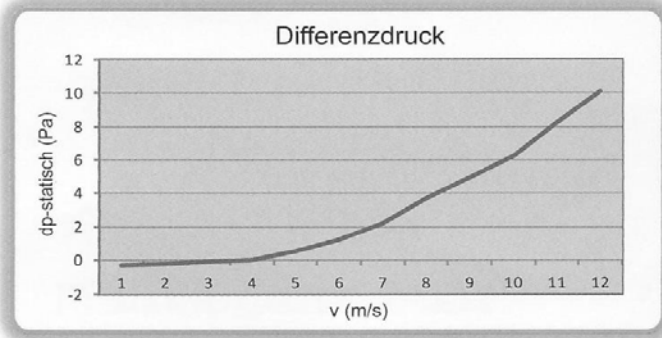

	Ø	80 mm	100 mm	125 mm	150 mm
Kupfer	p. St.	202.00	216.00	235.00	269.00
Aluman		175.00	187.00	199.00	223.00
Einf. CrNiSt / Ant. Alu		197.00	208.00	221.00	247.00
Cr-Ni-Stahl		239.00	247.00	265.00	308.00





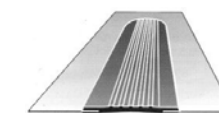

Technische Daten

NW	A	B	C	D	E	F	G	H
Ø 80	90	160	180	100	72	140	150	400
Ø 100	110	198	216	100	72	160	150	400
Ø 125	145	236	265	100	72	185	150	400
Ø 150	172	286	308	100	72	210	150	400

**320-01 Dilaprene 1-Kopf, beidseitig vulkanisiert, 390 mm breit**

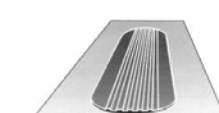

	Länge	850 mm	1000 mm	1250 mm	1500 mm	1800 mm		
	Kupfer	0.60	p. St.	63.00	75.00	107.00	135.00	170.00
	Aluman	1.20		42.00	50.00	81.00	111.00	136.00
	Cr-Ni-Stahl	0.50		48.50	57.00	81.00	98.00	138.00
	Zink	0.70		45.00	51.00	77.00	91.00	133.00
	RZ vorbereit.	0.80		53.00	59.00	82.50	102.00	144.00
	Uginox	0.50		51.00	61.00	84.00	99.00	140.00
	Matt+ RI-Pearl	0.50		51.00	61.00	84.00	-	-
Gewährleistungsvertrag	Tecu-Zinn	0.60		97.00	121.00	174.00	218.00	278.00

**320-02 Dilaprene 2-Kopf, beidseitig vulkanisiert, 390 mm breit**

	Länge	1500 mm	2000 mm		
	Kupfer	0.60	p. St.	*	*
	Aluman	1.20		*	*
	Cr-Ni-Stahl	0.50		*	*
	Zink	0.70		*	*
	RZ vorbereit.	0.80		*	*
	Uginox	0.50		*	*
Gewährleistungsvertrag	Tecu-Zinn	0.60		*	*

\* auf Anfrage

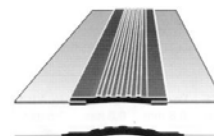
**320-03 Dilaprene endlos, beidseitig vulkanisiert, 390 mm breit**

		Länge		6 m	9 m	10 m
	Kupfer	0.60	p. m.	66.00	110.00	120.00
	Aluman	1.20		42.00	-	-
	Aluman	1.50		71.00	-	-
	Cr-Ni-Stahl	0.50		46.00	-	93.00
	Zink	0.70		45.00	-	-
	RZ vorbereit.	0.80		52.00	-	-
	Uginox	0.50		47.00	-	-
	Matt+ RI-Pearl	0.50		47.00	-	-
	Tecu-Zinn	0.60		119.00	-	-



Gewährleistungsvertrag

**Empfohlene Dilatations-Abstände**

Distanz	Dila / Dila	Dila / Aussenecke	Dila / Innenecke
Kupfer	6.00 m	3.00 m	1.50 m
Aluman	4.00 m	2.00 m	1.00 m
Cr-Ni-Stahl	6.00 m	3.00 m	1.50 m
Zink	5.00 m	2.50 m	1.25 m
Uginox	8.00 m	4.00 m	2.00 m
Tecu-Zinn	6.00 m	3.00 m	1.50 m

2019 / 11

**321-03 Shedrinnen Dila, endlos, Breite 330 mm**

		Länge		3000 mm
	Kupfer	0.60	p. m.	67.50
	Aluman	1.00		45.00
	Cr-Ni-Stahl	0.50		47.50
	Zink	0.70		46.50
	RZ vorbereit.	0.70		53.00
	Uginox	0.50		48.50
	Matt+ RI-Pearl	0.50		48.50

Gewährleistungsvertrag

Rinnenauflage:

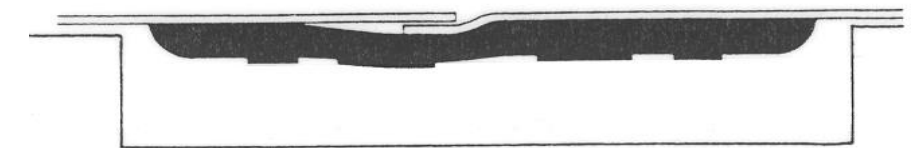

20 mm Raum für die Gummiausdehnung

2019 / 11



**321-21 Dilatop 1-Kopf, einseitig vulkanisiert, mit Deckel, 390 mm breit**

		Länge	850 mm	1000 mm	1250 mm	1500 mm	1800 mm	
   Gewährleistungsvertrag	Kupfer	0.60	p. St.	63.00	75.00	107.00	135.00	170.00
	Aluman	1.20		42.00	50.00	81.00	111.00	136.00
	Cr-Ni-Stahl	0.50		48.50	57.00	81.00	98.00	138.00
	Zink	0.70		45.00	51.00	77.00	91.00	133.00
	Uginox	0.50		51.00	61.00	84.00	99.00	140.00
	Matt+ RI-Pearl	0.50		51.00	61.00	84.00	99.00	140.00
	Tecu-Zinn	0.60		98.00	121.00	174.00	218.00	278.00

**321-22 Dilatop 2-Kopf, einseitig vulkanisiert, mit Deckel, 390 mm breit**

		Länge	1700 mm	2000 mm	
   Gewährleistungsvertrag	Kupfer	0.60	p. St.	*	*
	Aluman	1.20		*	*
	Cr-Ni-Stahl	0.50		*	*
	Zink	0.70		*	*
	Uginox	0.50		*	*
	Tecu-Zinn	0.60		*	*

\* auf Anfrage



**322-01 Dilaprene 1-Kopf beidseitig vulkanisiert, 390 mm breit**



		Länge	800 mm	830 mm	1000 mm	1300 mm	1500 mm	2000 mm	
 	Kupfer	0.55	p. St.	67.00	68.00	77.00	131.00	148.00	226.00
	Aluman	1.20		-	-	-	-	-	-
	Cr-Ni-Stahl	0.50		54.00	56.00	62.00	107.00	122.00	188.00
	Zink	0.70		58.00	60.00	68.00	116.00	131.00	201.00
	Matt+ RI-Pearl	0.50		59.00	60.00	68.00	116.00	131.00	200.00
	Uginox	0.50		57.00	59.00	67.00	114.00	129.00	197.00
	Tecu Zinn	0.60		94.00	97.00	111.00	175.00	-	-

**322-03 Dilaprene endlos, beidseitig vulkanisiert, 390 mm breit**



		Länge	3 m	6 m	
 	Kupfer	0.55	p. m.	67.00	67.00
	Aluman	1.20		51.00	51.00
	Cr-Ni-Stahl	0.50		53.00	53.00
	Zink	0.70		58.00	58.00
	RZ vorbereit.	0.80		-	-
	Uginox	0.50		57.00	57.00
	Matt+ RI-Pearl	0.50		58.00	58.00
	Tecu Zinn	0.60		-	-





**322-21 Dilastar 1-Kopf einseitig vulkanisiert, mit Deckel, 375 mm breit**

	Länge	800 mm	830 mm	1000 mm	1300 mm	
 	Kupfer	0.55 p. St.	76.00	74.00	89.00	137.50
	Aluman	1.20	53.00	54.00	62.00	103.00
	Cr-Ni-Stahl	0.50	55.00	54.00	68.00	104.00
	Zink	0.70	61.00	62.00	71.00	116.00
	Matt+ RI-Pearl	0.50	63.00	64.00	75.00	122.00
	Uginox	0.50	57.00	58.00	64.50	106.00
	Tecu Zinn	0.60	120.00	122.00	144.00	217.00



**322-22 Dilastar 2-Kopf einseitig vulkanisiert, mit Deckel, 375 mm breit**

	Länge	1500 mm	
 	Kupfer	0.55 p. St.	172.00
	Aluman	1.20	-
	Cr-Ni-Stahl	0.50	130.00
	Zink	0.70	140.00
	Matt+ RI-Pearl	0.50	147.00
	Uginox	0.50	132.00
	Tecu Zinn	0.60	-

**322-23 Dilastar endlos, 375 mm breit**

	Länge	3000 mm	
 	Kupfer	0.55 p. m	81.00
	Aluman	1.20	55.00
	Cr-Ni-Stahl	0.50	60.00
	Zink	0.70	65.00
	Matt+ RI-Pearl	0.50	69.00
	Uginox	0.50	62.00
	Tecu Zinn	0.60	126.00

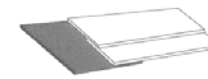
**322-24 Dila 44, 375 mm breit**

	Länge	660 mm	820 mm	
	für Abw.	330 mm	500 mm	
 	Kupfer	0.55 p. St.	99.00	116.00
	Cr-Ni-Stahl	0.50	79.00	89.00
	Matt+ RI-Pearl	0.50	91.00	107.00
	Uginox	0.50	81.00	95.00

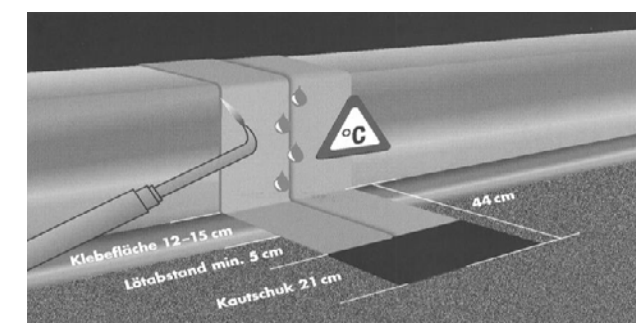

**Wichtiger Hinweis**  
Der Blechteil der Dila 44 ist während des Lötvorganges zu kühlen. Der Lötastand von min. 5 cm zum Kautschuk-Kopfteil muss



**330-11 Kieswinkel**

alle 100 mm gelocht Ø 15 mm, Länge 2 / 3 m

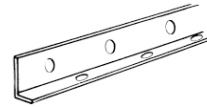

	Dim. Dicke gelocht		50/30 mm	60/40 mm	60/40 mm
Kupfer	p. m.	à 2 m	17.00	-	21.00
Cr-Ni-Stahl		à 2 / 3 m	6.70	7.10	10.50

	Dim. Dicke gelocht		60/40 mm	100/40 mm
Kupfer	p. m.	à 2 m	26.00	39.00
Cr-Ni-Stahl		à 2 m / 3 m	12.00	3 m 19.80

**330-15 Kiesschiene mit Abbug**

alle 100 mm gelocht 30 x 10 mm, Kiesschielenlänge 3 m

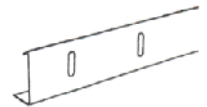

	Dim. Dicke		40/30 mm	60/30 mm
verzinkt	p. m.		8.50	9.20
Kupfer			15.90	27.00
Cr-Ni-Stahl			11.00	13.50

**330-97 Kieswinkel-Bride, mit Nietlöchern**



	Abw.	40/30 mm	50/30 mm	60/30 mm	60/40 mm
Kupfer	p. St.	3.20	3.20	3.20	3.20
Cr-Ni-Stahl		2.60	2.60	2.60	2.80

2019 / 11



**340-30 Deckstreifen auf Beton, Abw. 90 mm**

gelocht alle 200 mm, Loch Ø 8 mm

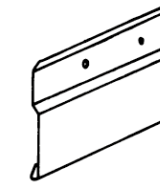

		Länge	2 m
Kupfer	0.60 p. m.		22.50
Cr-Ni-Stahl	0.50		7.90
Zink	0.70		8.90
Uginox	0.50		8.90

weitere Dimensionen auf Anfrage

**341-01 Befestigungsschiene für Foliendächer**

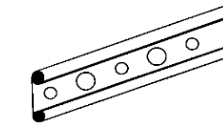

		Länge	3 m
verzinkt	p. m.	27 / 7 / 1.5 mm	2.50

2019 / 11

**345-01 Hohlfach-Profil ungelocht**

		Länge	5 m
	Aluminium p. m.	30 x 5 mm	*
	Aluminium	40 x 5 mm	*
	Cr-Ni-Stahl	30 x 1 mm	*
	Cr-Ni-Stahl	40 x 1 mm	*

**345-06 Hohlfach-Profil gelocht**

		Länge Lochung	5 m Ø 5 mm
	Aluminium p. m.	30 x 5 mm, alle 175 mm gelocht	*
	Aluminium	40 x 5 mm, alle 175 mm gelocht	*
	Cr-Ni-Stahl	30 x 1 mm, alle 150 mm gelocht	*
	Cr-Ni-Stahl	40 x 1 mm, alle 150 mm gelocht	*

\* auf Anfrage

**350-11 Ankerschiene ERA**

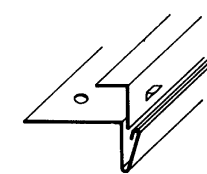
		Länge	2 m
	verzinkt p. m.		3.90
	beschichtet		4.40

**350-12 Abschluss-Schiene**

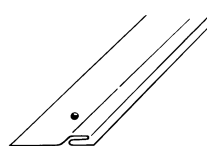
		Länge Lochung	2,5 m Ø 8 mm
	beschichtet p. m.	alle 450 mm gelocht	3.30

2019 / 11

**350-51 Blech-Anschlussprofil für isolierte Fassaden MUKV**

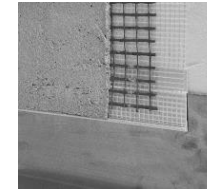

Keine Kälte- oder Wärmebrücke. Metallausdehnung gewährleistet. Problemlose Verbindung an Ecken, Stößen und Übergängen. Abziehkante für Gipser. Keine Verfärbung am Putz. 100% korrosionsfrei - für alle Metalle geeignet. Optimale Verbindung zwischen den Arbeiten von Spengler / Maurer, Gipser.

		Länge	2500 mm
Kunststoff	p. m.		10.50

**350-52 Blech-Anschlussprofil für Mauerwerk MUK**



Für die einfache und sichere Befestigung von Abdeckblechen. Kein Abreißen des Putzes und keine Verfärbung durch Metallauswaschung. Ausdehnung der Bleche im Profil möglich. Eckausbildung problemlos erstellbar. Stösse ohne Nieten und Lötten.

		Länge	2500 mm
Metall / Kunststoff	p. m.		11.00

2019 / 11

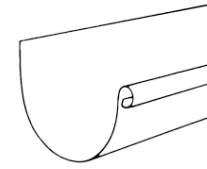

**101-01 Dachrinne**

Länge 6 m	Abw.	200 mm	250 mm	330 mm	400 mm
 verzinkt	0.62	p. m	-	*	*
Kupfer	0.60	-	*	*	*
Cr-Ni-Stahl	0.50	*	*	*	*
Matt+ RI-Pearl	0.50	-	*	*	*
Zink	0.70	*	*	*	*
RZ vorbewittert	0.70	-	*	*	*
Uginox	0.50	-	*	*	*

\* auf Anfrage

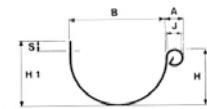

Abw. / dév.	200 mm	250 mm	330 mm	400 mm	500 mm
<b>B</b>	90	120	150	180	250
<b>H</b>	50	65	90	110	135
<b>H1</b>	57	70	102	130	165
<b>S</b>	7	5	12	20	30
<b>J</b>	14	16	18	18	18
<b>A</b>	16	18	20	20	20
<b>Querschnitt cm<sup>2</sup></b>	36	62	110	163	270

**101-95 Rinnenwulstverstärkung**

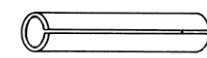
Verpackungseinheit 60/102 m (Länge 6 m )	Abw.	250 mm	330 mm
 Stahl plast.	Ø	16 mm	18 mm
	p. m	VPE 60 m	3.30
Kunststoff		VPE 102 m	3.00

2019 / 11

**101-02 Dachrinne eckig**

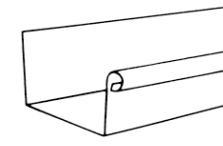
Länge 6 m	Abw.	200 mm	250 mm	330 mm	400 mm
 Kupfer 0.60	p. m	*	*	*	*
Cr-Ni-Stahl 0.50		-	*	*	*
Matt+ RI-Pearl 0.50		-	*	*	*
Zink 0.70		-	*	*	*
RZ vorbewittert 0.70		-	*	*	*
Uginox 0.50		-	*	*	*

\* auf Anfrage

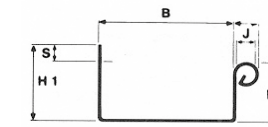



Abw. / dév.	200 mm	250 mm	330 mm	400 mm	500 mm
<b>B</b>	70	95	135	150	200
<b>H</b>	40	50	65	90	110
<b>H1</b>	48	62	77	102	140
<b>S</b>	8	12	12	12	30
<b>J</b>	14	16	18	18	18
<b>A</b>	16	18	20	20	20
<b>Querschnitt cm<sup>2</sup></b>	28	47	88	135	220



2019 / 11



**101-85 Rinnen-Dilaprene eckig, Länge 330 mm, einseitig vulkanisiert**

	Abw.	200 mm	250 mm	330 mm	400 mm	
	Kupfer	0.60 p. St.	-	29.00	33.00	37.00
	Cr-Ni-Stahl	0.50	-	20.00	23.00	26.00
	Matt+ RI-Pearl	0.50	-	21.00	24.00	27.00
	Zink	0.70	-	19.00	21.50	25.00
	RZ vorbereitert	0.80	-	20.00	22.50	-
Gewährleistungsvertrag	Uginox	0.50	-	21.00	24.00	27.00

**101-89 Rinnen-Dilaprene, Länge 330 mm, einseitig vulkanisiert**

	Abw.	200 mm	250 mm	330 mm	400 mm	
	Kupfer	0.60 p. St.	-	20.50	23.10	28.00
	Cr-Ni-Stahl	0.50	-	13.90	16.10	21.10
	Matt+ RI-Pearl	0.50	-	15.40	16.80	21.70
	Zink	0.70	-	16.10	18.50	21.10
Gewährleistungsvertrag	RZ vorbereitert	0.80	-	17.10	19.50	-
	Uginox	0.50	-	15.40	16.80	-

2019 / 11



**101-90 Laubschutz gutter stark, für Dachrinne rund oder eckig**

	Länge 2.0 m	Abw.	250 mm	330 mm	400 mm
	Alu blank	p.m. für Cr-Ni-St, Uginox, Zink	13.80	17.50	19.90
	Alu schutzeloziert	p.m. für Kupfer	22.90	23.50	26.50

**101-91 Laubstopp, für Dachrinne rund oder eckig**

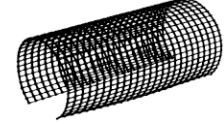
	Länge 3.0 m	250 - 400 mm	
	HDPE schwarz	p. m	6.90

**101-96 Rinnen-Bride**

	für Abw.	250 / 330 mm	400 / 500 mm	
	Länge	395 mm	495 mm	
	verzinkt	p. St. 25/1.5 mm	2.10	-
	Kupfer	27/2.0 mm	3.90	6.90
	Cr-Ni-Stahl	25/1.5 mm	2.80	5.40

**101-97 Rinnen-Verbinder**

	Abw.	200 mm	250 mm	330 mm	400 mm	
	verzinkt	p. St.	-	16.50	17.50	-
	Kupfer		-	22.00	23.00	-
	Cr-Ni-Stahl		-	21.00	22.00	-
	Zink		-	21.00	22.00	-

2019 / 11

**102-02 Rinnenhaken**

	Abw.	200 mm	250 mm	330 mm	400 mm
 verzinkt	p. St.	-	*	*	*
Kupfer		*	*	*	*
Cr-Ni-Stahl		*	*	*	*
Zink ummantelt		-	*	*	*
RZ vorbewittert umm.		-	*	*	-

**102-03 Rinnenhaken U**

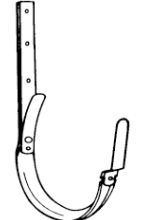
	Abw.	200 mm	250 mm	330 mm	400 mm
 Kupfer	p. St.	-	*	*	-
Cr-Ni-Stahl		-	*	*	-

**102-04 Rinnenhaken F zum Anschrauben**

	Abw.	200 mm	250 mm	330 mm	400 mm
 Kupfer	p. St.	-	7.00	7.40	-
Cr-Stahl		-	4.80	5.20	-

**102-06 Rinnenhaken eckig**

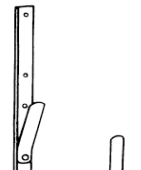
	Abw.	200 mm	250 mm	330 mm	400 mm
 Kupfer	p. St.	*	*	*	*
Cr-Ni-Stahl		*	*	*	*

\* auf Anfrage

**102-15 Rinnenhaken hochkant, gerade, mit angenieteter Einlage**

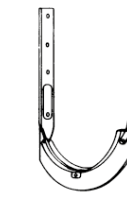
	Abw.	200 mm	250 mm	330 mm	400 mm
 verzinkt	p. St.	-	*	*	*
Kupfer		-	*	*	*
Cr-Ni-Stahl		-	*	*	*

**102-21 Rinnenhaken hochkant, gerade, mit durchgehender Feder**

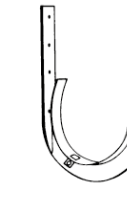
	Abw.	200 mm	250 mm	330 mm	400 mm
 verzinkt	p. St.	*	*	*	*
Kupfer		*	*	*	*
Cr-Ni-Stahl		*	*	*	*

**102-22 Rinnenhaken hochkant, abgedreht, mit durchgehender Feder**

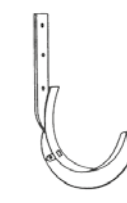
	Abw.	200 mm	250 mm	330 mm	400 mm
 verzinkt	p. St.	*	*	*	*
Kupfer		*	*	*	*
Cr-Ni-Stahl		*	*	*	*

**102-26 Rinnenhaken hochkant, zum seitlich Montieren 25°, mit angen. Einlage**

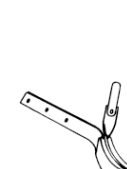
	Abw.	200 mm	250 mm	330 mm	400 mm
 Kupfer	p. St.	*	*	*	*
Cr-Ni-Stahl		*	*	*	*

\* auf Anfrage

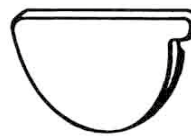

**103-00 Ansteckboden zum Anlöten links**

Kartons à 25 Stück		Abw.	200 mm	250 mm	330 mm	400 mm
	verzinkt	p. St.	-	8.60	8.60	-
	Kupfer		12.30	7.75	7.85	-
	Cr-Ni-Stahl		16.00	9.40	9.50	-
	Matt+ RI-Pearl		-	12.80	12.90	-
	Zink		-	8.80	8.90	-
	RZ vorbewittert		-	11.60	11.60	-
	Uginox		-	10.00	10.10	-

**103-01 Ansteckboden zum Anlöten rechts**

Kartons à 25 Stück		Abw.	200 mm	250 mm	330 mm	400 mm
	verzinkt	p. St.	-	8.60	8.60	-
	Kupfer		12.30	7.75	7.85	-
	Cr-Ni-Stahl		16.00	9.40	9.50	-
	Matt+ RI-Pearl		-	12.80	12.90	-
	Zink		-	8.80	8.90	-
	RZ vorbewittert		-	11.60	11.60	-
	Uginox		-	10.00	10.10	-

**103-02 Anfalzboden "Lipp" links + rechts**

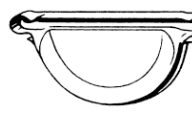
Kartons à 50 Stück		Abw.	200 mm	250 mm	330 mm	400 mm
	verzinkt	p. St.	-	1.30	1.40	1.90
	Kupfer		-	2.10	2.35	3.65
	Zink		-	1.75	1.95	2.55

**103-03 Anfalzboden "Swiss Made" links + rechts**

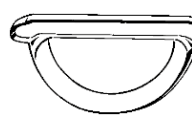
Kartons à 25 Stück		Abw.	200 mm	250 mm	330 mm	400 mm
	verzinkt	p. St.	-	2.15	2.30	-
	Kupfer		-	2.55	2.65	-
	Cr-Ni-Stahl		-	3.60	3.70	-
	Matt+ RI-Pearl		-	3.85	3.95	-
	Zink		-	2.85	2.95	-
	Uginox		-	3.30	3.40	5.90



**103-05 Anklemboden links**

Kartons à 25 Stück	Abw.	200 mm	250 mm	330 mm	400 mm
verzinkt	p. St.	-	5.30	5.40	10.60
Kupfer		7.10	5.05	5.15	9.90
Cr-Ni-Stahl		7.10	5.00	5.10	10.20
Matt+ RI-Pearl		-	6.70	6.80	-
Zink		7.10	5.35	5.45	10.90
RZ vorbewittert		-	9.80	9.90	-
Uginox		-	5.40	5.50	-

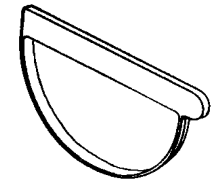

**103-06 Anklemboden rechts**

Kartons à 25 Stück	Abw.	200 mm	250 mm	330 mm	400 mm
verzinkt	p. St.	-	5.30	5.40	10.60
Kupfer		7.10	5.05	5.15	9.90
Cr-Ni-Stahl		7.10	5.00	5.10	10.20
Matt+ RI-Pearl		-	6.70	6.80	-
Zink		7.10	5.35	5.45	10.90
RZ vorbewittert		-	9.80	9.90	-
Uginox		-	5.40	5.50	-

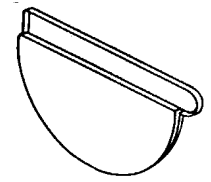

**103-10 Nockenzange für Anklemböden**

	88.00
--	-------

2019 / 11



**103-07 Anklemboden, eckig links**

Kartons à 25 Stück	Abw.	200 mm	250 mm	330 mm	400 mm
Kupfer	p. St.	8.80	7.40	7.50	15.10
Cr-Ni-Stahl		9.50	8.80	9.00	15.80
Matt+ RI-Pearl		-	15.00	15.10	-
Zink		-	9.20	9.30	15.80
RZ vorbewittert		-	-	-	-
Uginox		-	10.60	10.70	-

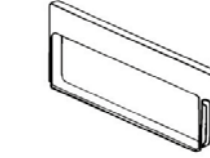

**103-08 Anklemboden, eckig rechts**

Kartons à 25 Stück	Abw.	200 mm	250 mm	330 mm	400 mm
Kupfer	p. St.	8.80	7.40	7.50	15.10
Cr-Ni-Stahl		9.50	8.80	9.00	15.80
Matt+ RI-Pearl		-	15.00	15.10	-
Zink		-	9.20	9.30	15.80
RZ vorbewittert		-	-	-	-
Uginox		-	10.60	10.70	-

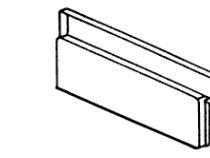

2019 / 11



**103-11 Rinnenkugelboden, zum Anlöten links + rechts**



Kartons à 25 Stück	Abw.	200 mm	250 mm	330 mm	400 mm
Kupfer	p. St.	21.00	14.60	14.60	31.00*
Cr-Ni-Stahl		-	16.80	16.80	-
Matt+ RI-Pearl		-	22.70	22.70	-
Zink		-	19.40	19.40	-
RZ vorbewittert		-	-	-	-
Uginox		-	20.70	20.70	-

\* Abw. 400 mm: ohne Lasche zum Lötten

2019 / 11



**104-01 Rinnenstutzen, zum Einhängen**

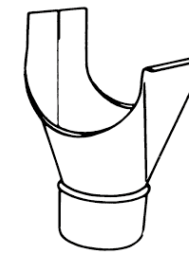

Kartons à 25 Stück	Abw. / Ø	200/50 mm	200/60 mm	250/60 mm	250/75 mm	250/100 mm
verzinkt	p. St.	-	-	-	5.80	-
Kupfer		21.00	17.00	17.00	6.60	17.00
Cr-Ni-Stahl		-	15.00	13.00	7.20	14.00
Matt+ RI-Pearl		-	-	-	8.50	29.50
Zink		19.00	15.00	15.00	5.50	16.00
RZ vorbewittert		-	-	-	14.20	-
Uginox		-	-	15.00	8.50	20.00

Kartons à 25 Stück	Abw. / Ø	330/75 mm	330/100 mm	330/120 mm	400/100 mm	400/120 mm
verzinkt	p. St.	5.00	5.00	-	-	-
Kupfer		6.95	6.95	15.50	18.50	18.50
Cr-Ni-Stahl		7.55	7.55	10.90	11.90	11.90
Matt+ RI-Pearl		9.10	9.10	-	25.60	25.60
Zink		5.85	5.85	13.50	16.80	16.80
RZ vorbewittert		14.75	14.75	-	-	-
Uginox		9.10	9.10	14.00	16.00	16.00

2019 / 11



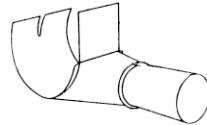

**104-51 Schrägstutzen, zum Einhängen**

	Abw. / Ø	250/75 mm	330/75 mm	330/100 mm
	verzinkt p. St.	38.00	39.00	40.00
	Kupfer	41.00	42.00	43.00
	Cr-Ni-Stahl	53.00	54.00	55.00
	Matt+ RI-Pearl	58.00	59.00	60.00
	Zink	41.00	42.00	43.00
	RZ vorbewittert	59.00	60.00	61.00
	Uginox	54.00	55.00	56.00

**104-41 Rinnenstutzen eckig, zum Einhängen**

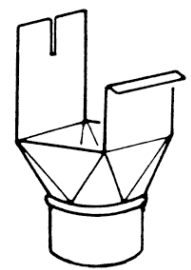
	Abw. / Ø	200/60 mm	250/75 mm	330/75 mm
	Kupfer p. St.	74.00	67.00	69.00
	Cr-Ni-Stahl	46.00	42.00	43.00
	Matt+ RI-Pearl	-	47.00	48.00
	Zink	64.00	58.00	60.00
	Uginox	-	51.00	48.00

	Abw. / Ø	330/100 mm	400/100 mm	400/120 mm
	Kupfer p. St.	69.00	73.00	73.00
	Cr-Ni-Stahl	43.00	45.00	45.00
	Matt+ RI-Pearl	48.00	50.00	-
	Zink	60.00	63.00	63.00
	Uginox	48.00	55.00	55.00



**105-01 Rinnenkasten, Wulst 3-seitig**

	Ø	75 mm	100 mm	120 mm
	Grösse	220 x 220 mm	220 x 220 mm	220 x 220 mm
	Höhe	270 mm	300 mm	300 mm
	verzinkt p. St.	50.00	52.00	55.00
	Kupfer	81.30	82.40	99.00
	Cr-Ni-Stahl	64.50	65.50	80.00
	Matt+ RI-Pearl	79.20	80.20	94.00
	Zink	70.80	71.80	86.00
	RZ vorbewittert Boden gerade	*	*	*
	Uginox	72.30	71.30	*

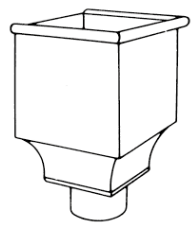
**105-03 Rinnenkasten, Wulst eckig 3-seitig**

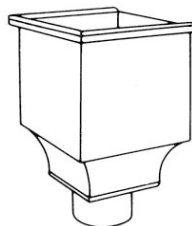
	Ø	75 mm	100 mm	120 mm
	Grösse	220 x 220 mm	220 x 220 mm	220 x 220 mm
	Höhe	300 mm	300 mm	300 mm
	verzinkt p. St.	-	-	-
	Kupfer	*	*	*
	Cr-Ni-Stahl	*	*	*
	Matt+ RI-Pearl	*	*	*
	Zink	*	*	*
	RZ vorbewittert Boden gerade	*	*	*
	Uginox	*	*	*

\* auf Anfrage

2019 / 11

**105-08 Rinnenkasten, Wulst 3-seitig, EXZENTRISCH**

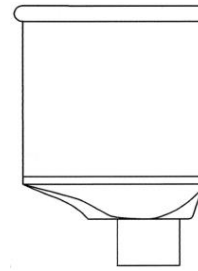
	Ø	75 mm			100 mm			120 mm		
		Grösse			Grösse			Grösse		
		220 x 220 mm			220 x 220 mm			220 x 220 mm		
		Höhe			Höhe			Höhe		
		300 mm			300 mm			300 mm		
	Kupfer	p. St.	111.00	113.00	*					
	Cr-Ni-Stahl		97.00	99.00	*					
	Matt+ RI-Pearl		110.00	112.00	*					
	Zink		98.00	100.00	*					
	Uginox		101.00	103.00	*					

**105-09 Rinnenkasten, Wulst eckig 3-seitig, EXZENTRISCH**

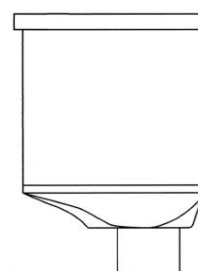
	Ø	75 mm			100 mm			120 mm		
		Grösse			Grösse			Grösse		
		220 x 220 mm			220 x 220 mm			220 x 220 mm		
		Höhe			Höhe			Höhe		
		300 mm			300 mm			300 mm		
	Kupfer	p. St.	*	*	*					
	Cr-Ni-Stahl		*	*	*					
	Matt+ RI-Pearl		*	*	*					
	Zink		*	*	*					
	Uginox		*	*	*					

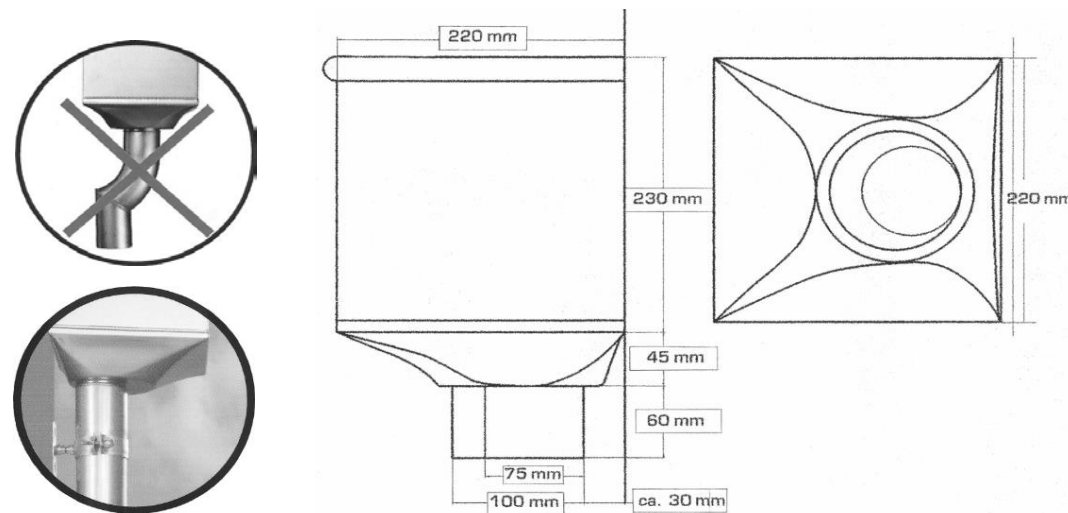

**105-31 Fassadenkasten MODERNA rund, KLEIN 180 mm**

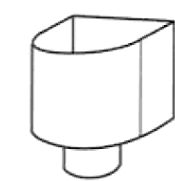
	Ø	60 mm		75 mm		100 mm	
		Breite		Breite		Breite	
		180 mm		180 mm		180 mm	
		Gesamthöhe		Gesamthöhe		Gesamthöhe	
		240 mm		240 mm		240 mm	
	Kupfer	p. St.	*	99.30	99.30		
	Cr-Ni-Stahl		*	96.00	96.00		
	Matt+ RI-Pearl		*	105.00	105.00		
	Zink		*	94.00	94.00		
	Uginox		*	99.30	99.30		

**105-32 Fassadenkasten MODERNA rund, GROSS 240 mm**

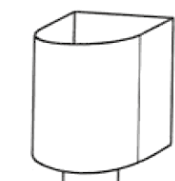
	Ø	75 mm		100 mm		120 mm	
		Breite		Breite		Breite	
		180 mm		180 mm		180 mm	
		Gesamthöhe		Gesamthöhe		Gesamthöhe	
		290 mm		290 mm		290 mm	
	Kupfer	p. St.	100.30	100.30	*		
	Cr-Ni-Stahl		97.00	97.00	*		
	Matt+ RI-Pearl		106.70	106.70	*		
	Zink		95.00	95.00	*		
	Uginox		100.30	100.30	*		

**105-33 Fassadenkasten MODERNA rund, XL 290 mm**

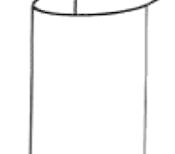
	Ø	75 mm		100 mm		120 mm	
		Breite		Breite		Breite	
		180 mm		180 mm		180 mm	
		Gesamthöhe		Gesamthöhe		Gesamthöhe	
		340 mm		340 mm		340 mm	
	gleicher Preis wie Artikel 105-32						

2019 / 11



**105-36 Fassadenkasten MODERNA eckig, KLEIN 180 mm**

		Ø 60 mm	75 mm	100 mm	
	Breite	180 mm	180 mm	180 mm	
	Gesamthöhe	240 mm	240 mm	240 mm	
	Kupfer	p. St.	*	100.30	100.30
	Cr-Ni-Stahl		*	97.00	97.00
	Matt+ RI-Pearl		*	106.70	106.70
Zink		*	95.00	95.00	
Uginox		*	100.30	100.30	

**105-37 Fassadenkasten MODERNA eckig, GROSS 240 mm**

		Ø 75 mm	100 mm	120 mm	
	Breite	180 mm	180 mm	180 mm	
	Gesamthöhe	290 mm	290 mm	290 mm	
	Kupfer	p. St.	100.30	100.30	*
	Cr-Ni-Stahl		98.20	98.20	*
	Matt+ RI-Pearl		106.70	106.70	*
Zink		96.00	96.00	*	
Uginox		101.50	101.50	*	

**105-38 Fassadenkasten MODERNA eckig, XL 290 mm**

		Ø 75 mm	100 mm	120 mm
	Breite	180 mm	180 mm	180 mm
	Gesamthöhe	340 mm	340 mm	340 mm
	gleicher Preis wie Artikel 105-37			

2019 / 11

\* auf Anfrage



**105-05 Rinnenkasten, Wulst 3-seitig, "Piccolo"**

		Ø 60 mm	75 mm	100 mm	
	Grösse	180 x 180 mm	180 x 180 mm	180 x 180 mm	
	Höhe	230 mm	230 mm	230 mm	
	verzinkt	p. St.	-	-	-
	Kupfer		*	79.20	80.30
	Cr-Ni-Stahl		*	61.30	62.30
	Matt+ RI-Pearl		*	75.00	76.00
	Zink		*	67.60	68.70
	RZ vorbewittert	Boden gerade	*	*	*
	Uginox		*	68.70	69.70

\* auf Anfrage

**Rinnenkasten, Wulst 4-seitig auf Anfrage**

**105-99 Stern zum Auflöten für alle Rinnenkasten**

	Kupfer / Zink	p. St.	10.00
--	---------------	--------	-------

**105-97 Rinnenseiher**

	Ø 50/60 mm	75 mm	100 mm	120 mm	
	Kupfer	4.60	4.60	4.90	5.90
	Cr-Ni-Stahl	-	4.85	5.25	6.45
	Ø 150 mm				
Kupfer	14.00				
Cr-Ni-Stahl	13.00				

2019 / 11

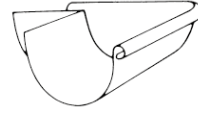

**106-01 Rinnenwinkel äussere, mit Naht**

	Abw.	200 mm	250 mm	330 mm	400 mm
 verzinkt	p. St.	-	29.90	30.30	-
Kupfer		52.70	36.50	39.50	86.00
Cr-Ni-Stahl		-	47.30	48.40	89.80
Matt+ RI-Pearl		-	57.00	58.00	-
Zink		-	36.50	37.50	-
RZ vorbewittert		-	67.50	68.50	-
Uginox		-	52.80	53.90	-

**106-02 Rinnenwinkel äussere, gepresst, ohne Naht**

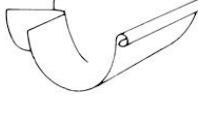
	Abw.	200 mm	250 mm	330 mm	400 mm
 Kupfer	p. St.	-	21.50	24.50	-
Zink		-	19.00	20.50	-
Uginox		-	32.00	33.00	-

2019 / 11

**106-11 Rinnenwinkel innere, mit Naht**

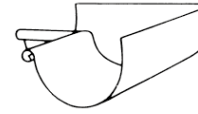
	Abw.	200 mm	250 mm	330 mm	400 mm
 verzinkt	p. St.	-	29.90	30.30	-
Kupfer		52.70	36.50	39.50	86.00
Cr-Ni-Stahl		-	47.30	48.40	89.80
Matt+ RI-Pearl		-	57.00	58.00	-
Zink		-	36.50	37.50	-
RZ vorbewittert		-	67.50	68.50	-
Uginox		-	52.80	53.90	-

**106-12 Rinnenwinkel innere, gepresst, ohne Naht**

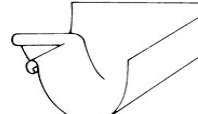
	Abw.	200 mm	250 mm	330 mm	400 mm
 Kupfer	p. St.	-	21.50	24.50	-
Zink		-	19.00	20.50	-
Uginox		-	32.00	33.00	-

2019 / 11

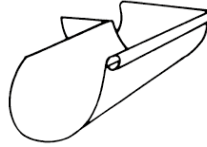

**106-51 Gehrschildwinkel, links**

	Abw.	250 mm	330 mm
	Kupfer gepresst	p. St.	30.00 -
	Kupfer mit Naht		61.00 64.50
	Cr-Ni-Stahl		69.00 88.00
	Matt+ RI-Pearl		71.50 93.00
	Zink gepresst		23.20 -
	Zink mit Naht		- 76.00
	Uginox		- -

**106-52 Gehrschildwinkel, rechts**

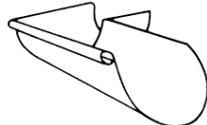
	Abw.	250 mm	330 mm
	Kupfer gepresst	p. St.	30.00 -
	Kupfer mit Naht		61.00 64.50
	Cr-Ni-Stahl		69.00 88.00
	Matt+ RI-Pearl		71.50 93.00
	Zink gepresst		23.20 -
	Zink mit Naht		- 76.00
	Uginox		- -

2019 / 11





**111-01 Ablaufrohr, geschweisst (gefalzt <sup>1</sup>)**

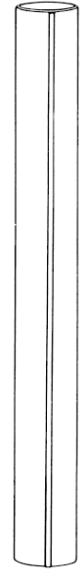

	Länge 1 m	Ø 40 mm	50 mm	60 mm
verzinkt	p. m	-	-	-
Kupfer		29.50 <sup>1</sup>	29.50 <sup>1</sup>	-
Cr-Ni-Stahl		26.00 <sup>1</sup>	26.00 <sup>1</sup>	-
Matt+ RI-Pearl		-	27.50 <sup>1</sup>	-
Zink		26.50 <sup>1</sup>	26.50 <sup>1</sup>	-
Uginox		26.00 <sup>1</sup>	26.00 <sup>1</sup>	* <sup>1</sup>

	Länge 2 m	Ø 40 mm	50 mm	60 mm
verzinkt	p. m	-	-	-
Kupfer		-	-	*
Cr-Ni-Stahl		-	-	*
Matt+ RI-Pearl		-	-	14.00
Zink		-	-	10.50
Uginox		-	-	19.50 <sup>1</sup>

	Länge 3 m	Ø 40 mm	50 mm	60 mm
Kupfer	p. m	-	-	*
Cr-Ni-Stahl		-	-	*
Zink		-	-	*

\* auf Anfrage

2019 / 11



**111-01 Ablaufrohr, geschweisst (gefalzt <sup>1</sup>)**

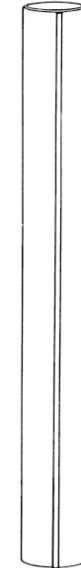

	Länge 2 m	Ø 75 mm	100 mm	120 mm
Kupfer	p. m	*	*	-
Cr-Ni-Stahl		*	*	-
Zink		*	*	-

	Länge 3 m	Ø 75 mm	100 mm	120 mm
verzinkt	p. m	* <sup>1</sup>	* <sup>1</sup>	* <sup>1</sup>
Kupfer		*	*	*
Cr-Ni-Stahl		*	*	*
Matt+ RI-Pearl		*	*	*
Zink		*	*	*
RZ vorbewittert		* <sup>1</sup>	*	*
Uginox		* <sup>1</sup>	* <sup>1</sup>	-

	Länge 4 m	Ø 75 mm	100 mm	120 mm
Kupfer	p. m	*	*	-
Cr-Ni-Stahl		*	*	-
Zink		*	*	-

\* auf Anfrage

2019 / 11





**111-03 Ablaufrohr eckig**



Länge 2 m	58 x 58 mm	78 x 78 mm	95 x 95 mm	120 x 120 mm
Kupfer	p. m	*	*	*
Cr-Ni-Stahl		*	*	*
Zink		*	*	*
Uginox		*	*	*

\* auf Anfrage

2019 / 11



**10008681 Ablaufrohr-Provisorium**

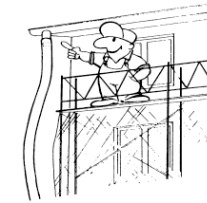

	Rolle à 100 m	für Rohr Ø	60-120 mm
Polyaethylen	p. St.		26.00

**10018001 Rohr-Provisorium Drainflex gelb**



	Rolle à 50 m	für Rohr Ø	100 mm
PVC gerillt	p. St.		195.00

**10018378 Rohr-Provisorium Rainflex schwarz einhängen, festzurren, fertig**



	Rolle à 6 m	für Rohr Ø	100 mm
Polyester-PET-Gewebe	p. St.		59.00

**111-51 Ablaufkette**



	Draht Ø 5,3 mm	Glieder	55 x 30 mm
		Länge	5 Meter
Kupfer	p. m		28.00
Cr-Ni-Stahl			28.00

2019 / 11



**111-81 Rohrabzweiger 70°**

Rohr ca. 400 mm, Abzweiger ca. 120 mm lang

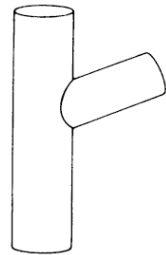

	Ø	75/60 mm	75/75 mm	100/60 mm	100/75 mm	100/100 mm
Kupfer	p. St.	115.00	115.00	125.00	125.00	125.00
Cr-Ni-Stahl		123.00	123.00	133.00	133.00	133.00
Zink		115.00	115.00	125.00	125.00	125.00
Matt+ RI-Pearl		150.00	150.00	160.00	160.00	160.00

**111-82 Rohrabzweiger 85°**

Rohr ca. 400 mm, Abzweiger ca. 120 mm lang

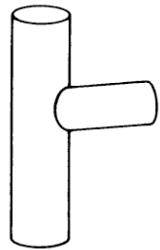

	Ø	75/60 mm	75/75 mm	100/60 mm	100/75 mm	100/100 mm
Kupfer	p. St.	115.00	115.00	125.00	125.00	125.00
Cr-Ni-Stahl		123.00	123.00	133.00	133.00	133.00
Zink		115.00	115.00	125.00	125.00	125.00
Matt+ RI-Pearl		150.00	150.00	160.00	160.00	160.00

weitere Grössen auf Anfrage

2019 / 11



**111-93 Einfachwulst, zum Klemmen**

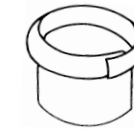

	Ø	75 mm	100 mm	120 mm
	Kartons à St.	40	40	20
Kupfer	p. St.	8.20	8.20	10.00
Cr-Ni-Stahl		6.80	7.10	8.60
Matt+ RI-Pearl		9.00	9.10	*
Zink		8.20	8.30	9.50
RZ vorbewittert		10.90	11.20	*
Uginox		7.70	7.90	10.20

**111-94 Doppelwulst, zum Klemmen**

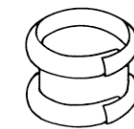

	Ø	75 mm	100 mm	120 mm
	Kartons à St.	25	20	10
Kupfer	p. St.	11.00	13.00	14.50
Cr-Ni-Stahl		*	*	*
Matt+ RI-Pearl		*	*	*
Zink		9.50	10.50	*
RZ vorbewittert		*	*	*
Uginox		*	*	*

**111-95 Endlos-Wulst**

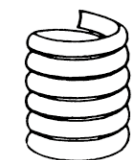

	Ø	75 mm	100 mm	120 mm	150 mm
	Umgänge	~ 6	~ 5	~ 4	~ 3
Kupfer	p. St.	*	*	*	*
Zink		*	*	*	*

\* auf Anfrage

2019 / 11

**111-96 Rohrweigeinlauf**

	Ø	50 mm	60 mm	75 mm	100 mm	
	Kupfer	p. St.	33.00	33.00	33.00	38.00
	Cr-Ni-Stahl		27.00	27.00	27.00	34.00
	Matt+ RI-Pearl		28.00	28.00	28.00	34.00
	Zink		28.00	28.00	28.00	32.00
	RZ vorbewittert		-	-	-	-
	Uginox		28.00	28.00	28.00	34.00

**111-97 Rohrsammeltrichter, zentrisch**

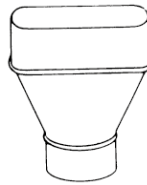
	Ø	75 mm	100 mm	
	Kupfer	p. St.	65.00	69.00
	Cr-Ni-Stahl		53.00	55.00
	Matt+ RI-Pearl		82.00	84.00
	Zink		53.00	56.00
	Uginox		55.00	57.00

**111-98 Rohrsammeltrichter, exzentrisch**

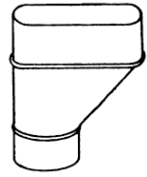
	Ø	75 mm	100 mm	120 mm	
	Kupfer	p. St.	65.00	69.00	75.00
	Cr-Ni-Stahl		53.00	55.00	58.00
	Matt+ RI-Pearl		82.00	84.00	-
	Zink		53.00	56.00	63.00
	Uginox		55.00	57.00	60.00

**112-01 Bogen 40°**

	Ø	75 mm	100 mm
	Kupfer	4.60 +	6.10 +
	Cr-Ni-Stahl	4.60 +	5.40 +
	+ solange Vorrat		

**112-11 Bogen 70° (1 = Ausführung gefalzt)**

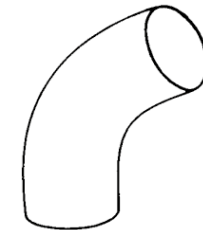
Kartons à 25 Stück	Ø	50 mm	60 mm	75 mm	100 mm	120 mm	
	verzinkt	p. St.	-	*	*	6.00	*
	Kupfer		13.00	4.60	*	*	10.20
	Cr-Ni-Stahl		-	5.40	4.60	5.40	8.40
	Matt+ RI-Pearl		-	9.10	8.60	9.40	*
	Zink		10.50	3.50	*	*	7.40
	RZ vorbewittert		-	-	*	10.50	*
	Uginox		-	7.60 <sup>1</sup>	7.60 <sup>1</sup>	8.40 <sup>1</sup>	12.90 <sup>1</sup>
	+ solange Vorrat * auf Anfrage						

**112-12 Bogen 72°**

Kartons à 25 Stück	Ø	75 mm	100 mm	
	Kupfer	p. St.	4.20	5.70
	Zink		3.50	3.90

2019 / 11



**112-21 Bogen 85° (1 = Ausführung gefalzt)**

Kartons à 25 Stück	Ø	50 mm	60 mm	75 mm	100 mm	120 mm
verzinkt	p. St.	-	*	*	*	*
Kupfer		15.00 <sup>1</sup>	5.40	*	*	11.20
Cr-Ni-Stahl		-	6.20	5.40	6.20	9.40
Matt+ RI-Pearl		-	10.30	9.80	10.60	*
Zink		-	4.30	*	*	8.40
RZ vorbewittert		-	-	*	18.00	*
Uginox		-	9.50 <sup>1</sup>	9.40 <sup>1</sup>	9.40 <sup>1</sup>	* <sup>1</sup>

+ solange Vorrat  
\* auf Anfrage

**112-22 Bogen 85°**

Kartons à 25 Stück	Ø	75 mm	100 mm
Kupfer	p. St.	5.10	6.50
Zink		3.90	4.70

2019 / 11



**113-01 Ablaufrohr-Winkel 45°**

	Ø	40 mm	50 mm	60 mm	75 mm	100 mm	120 mm	150 mm
Kupfer	p. St.	21.00	21.00	21.00	21.00	22.50	42.00	54.00
Cr-Ni-Stahl		20.50	20.50	20.50	20.50	22.00	42.00	52.00
Matt+ RI-Pearl		26.50	26.50	26.00	26.00	27.50	48.00	52.00
Zink		21.00	21.00	21.00	21.00	22.00	42.00	49.00
RZ vorbewittert		31.00	31.00	31.00	31.00	32.50	55.00	65.00
Uginox		28.00	28.00	25.50	25.50	26.00	49.00	52.00

**113-11 Ablaufrohr-Winkel 70°**

	Ø	40 mm	50 mm	60 mm	75 mm	100 mm	120 mm	150 mm
Kupfer	p. St.	21.00	21.00	21.00	21.00	22.50	42.00	54.00
Cr-Ni-Stahl		20.50	20.50	20.50	20.50	22.00	42.00	52.00
Matt+ RI-Pearl		26.50	26.50	26.00	26.00	27.50	48.00	52.00
Zink		21.00	21.00	21.00	21.00	22.00	42.00	49.00
RZ vorbewittert		31.00	31.00	31.00	31.00	32.50	55.00	65.00
Uginox		28.00	28.00	25.50	25.50	26.00	49.00	52.00

**113-21 Ablaufrohr-Winkel 85°**

	Ø	40 mm	50 mm	60 mm	75 mm	100 mm	120 mm	150 mm
Kupfer	p. St.	21.00	21.00	21.00	21.00	22.50	42.00	54.00
Cr-Ni-Stahl		20.50	20.50	20.50	20.50	22.00	42.00	52.00
Matt+ RI-Pearl		26.50	26.50	26.00	26.00	27.50	48.00	52.00
Zink		21.00	21.00	21.00	21.00	22.00	42.00	49.00
RZ vorbewittert		31.00	31.00	31.00	31.00	32.50	55.00	65.00
Uginox		28.00	28.00	25.50	25.50	26.00	49.00	52.00

2019 / 11





**113-41 Sockelwinkel, Bogenteil weit**

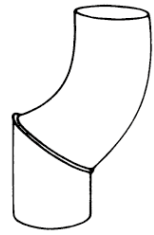

Ausladung 3 - 4 cm		Ø	75 mm	100 mm
verzinkt	p. St.		35.00	41.00
Kupfer			36.50	42.80
Cr-Ni-Stahl			48.10	52.30
Matt+ RI-Pearl			55.00	59.90
Zink			39.10	43.30
RZ vorbewittert			*	*
Uginox			47.00	50.70

**113-42 Sockelwinkel, Bogenteil weit**



Ausladung 5 - 7 cm		Ø	75 mm	100 mm
verzinkt	p. St.		35.00	41.00
Kupfer			36.50	42.80
Cr-Ni-Stahl			48.10	52.30
Matt+ RI-Pearl			55.00	59.90
Zink			39.10	43.30
RZ vorbewittert			*	*
Uginox			47.00	50.70

**113-43 Sockelwinkel, Bogenteil weit**

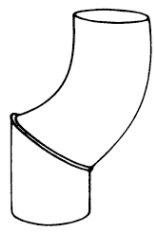

Ausladung 8 - 10 cm		Ø	75 mm	100 mm
verzinkt	p. St.		35.00	41.00
Kupfer			36.50	42.80
Cr-Ni-Stahl			48.10	52.30
Matt+ RI-Pearl			55.00	59.90
Zink			39.10	43.30
RZ vorbewittert			*	*
Uginox			47.00	50.70

\* auf Anfrage



**113-61 Etagenwinkel**

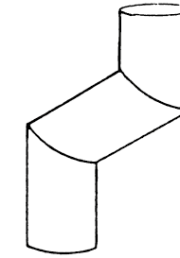

Ausladung 3-4, 5-7, 8-10, 11-13 cm		Ø	75 mm	100 mm	120 mm
Kupfer	p. St.		*	*	*
Cr-Ni-Stahl			*	*	*
Zink			*	*	*
RZ vorbewittert			*	*	*
Uginox			*	*	*

Ausladung 14-16, 17-19, 20-22, 23-25 cm		Ø	75 mm	100 mm	120 mm
Kupfer	p. St.		*	*	*
Cr-Ni-Stahl			*	*	*
Zink			*	*	*
RZ vorbewittert			*	*	*
Uginox			*	*	*

\* auf Anfrage



**113-70 Schwanenhals, gelötet Kupfer**

inkl. 85° Winkel, aus Einzelteilen gelötet

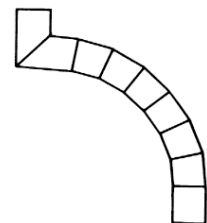

			Ø	60 mm	75 mm	100 mm	120 mm
Ausladung	30- 60 cm	p. St.		208.00	208.00	208.00	270.00
	61-70 / 71-80 / 81- 90 cm			247.00	247.00	247.00	305.00
	91-100 / 101-110 / 111-120 cm			289.00	289.00	289.00	350.00
	121-130 / 131-145 cm			327.00	327.00	327.00	390.00
	146-180 cm			363.00	363.00	363.00	425.00
	181-220 cm			410.00	410.00	410.00	475.00

**Schwanenhals, gelötet Zink**

inkl. 85° Winkel, aus Einzelteilen gelötet

			Ø	60 mm	75 mm	100 mm	120 mm
Ausladung	30- 60 cm	p. St.		208.00	208.00	208.00	270.00
	61-70 / 71-80 / 81- 90 cm			247.00	247.00	247.00	305.00
	91-100 / 101-110 / 111-120 cm			289.00	289.00	289.00	350.00
	121-130 / 131-145 cm			327.00	327.00	327.00	390.00
	146-180 cm			363.00	363.00	363.00	425.00
	181-220 cm			410.00	410.00	410.00	475.00

2019 / 11



**113-71 Schwanenhals, gepresst Kupfer**

inkl. 85° Winkel

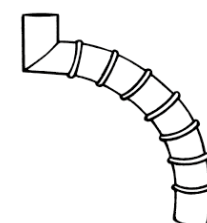

			Ø	75 mm	100 mm	120 mm
Ausladung	30- 60 cm	p. St.		178.00	188.00	208.00
	61-70 / 71-80 / 81- 90 cm			198.00	208.00	228.00
	91-100 / 101-110 / 111-120 cm			220.00	230.00	250.00
	121-130 / 131-145 cm			250.00	260.00	280.00
	146-180 cm			280.00	290.00	310.00
	181-220 cm			298.00	308.00	328.00

**Schwanenhals, gepresst Zink**

inkl. 85° Winkel

Verpackungseinheit 2			Ø	75 mm	100 mm	120 mm
Ausladung	30- 60 cm	p. St.		178.00	188.00	208.00
	61-70 / 71-80 / 81- 90 cm			198.00	208.00	228.00
	91-100 / 101-110 / 111-120 cm			220.00	230.00	250.00
	121-130 / 131-145 cm			250.00	260.00	280.00
	146-180 cm			280.00	290.00	310.00
	181-220 cm			298.00	308.00	328.00

Schwanenhälse in Cr-Ni-St und Uginox gleicher Preis

2019 / 11

**114-21 Wasserfalle, verdeckt und offen**

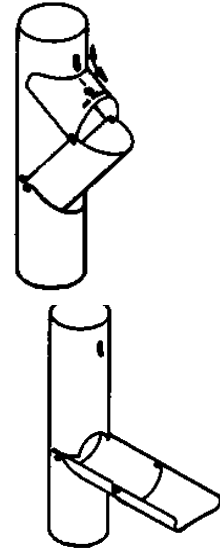
	Ø	60 mm	75 mm	100 mm	120 mm	
	verzinkt	p. St.	-	33.00	41.00	-
	Kupfer		65.00	52.30	55.50	65.00
	Cr-Ni-Stahl		65.00	52.80	55.00	65.00
	Matt+ RI-Pearl		-	53.90	56.20	-
	Zink		64.00	51.20	54.40	-
	RZ vorbewittert		-	68.50	73.00	-
	Uginox		-	49.10	51.20	-

**114-31 Wasserklappe GR**

mit Laubsieb aus Edelstahl (Ø 75+100)

	Ø	60 mm	75 mm	100 mm	120 mm	
	Kupfer	p. St.	65.00	32.50	33.50	65.00
	Zink		64.00	23.00	24.00	29.00
	Uginox		-	32.50	33.50	41.00

(ohne Laubsieb)



2019 / 11

**114-56 Wassersammler, mit Schlauchanschluss 3/4"**

	Ø	75 mm	100 mm	
	Kupfer	p. St.	129.00	133.00
	Cr-Ni-Stahl		153.00	162.00
	Zink		124.00	128.00

**114-61 Wasserklappe mit Schwimmer**

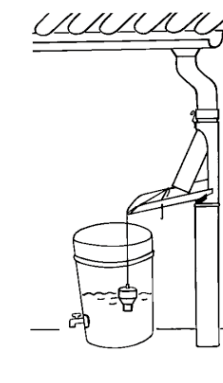
	Ø	75 mm	100 mm	
	Kupfer	p. St.	99.00	99.00
	Cr-Ni-Stahl		119.00	119.00
	Zink		96.00	96.00
	Uginox		119.00	119.00

**114-62/63 Wasserfass aus PE, grün**

inkl. Deckel, Auslaufhahn in Messing 3/4"

Inhalt	Höhe	Ø	Preis	Höhe	Preis
<b>Fass rund</b>			<b>Ständer PE Grün</b>		
205 lt	760 mm	710 mm	198.00	330 mm	69.00
300 lt	800 mm	816 mm	265.00	330 mm	75.00
500 lt	1025 mm	936 mm	325.00	330 mm	79.00



2019 / 11

### 115-01 Übergangsstück

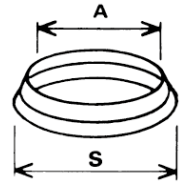

Kartons à 20 Stück		A / S	A / S	A / S	A / S	A / S
mm		60/72	75/85	75/92	75/98	75/103
Kupfer	p. St.	4.60	4.80	4.80	5.00	5.40
Zink		4.60	4.80	4.80	5.00	5.40
Cr-Ni-Stahl		-	7.70	7.70	-	-

Kartons à 20 Stück		A / S	A / S	A / S	A / S	A / S
mm		75/106	75/110	75/114	75/122	100/110
Kupfer	p. St.	5.70	6.40	6.90	7.40	4.90
Zink		5.70	6.40	6.90	7.40	4.90
Cr-Ni-Stahl		-	-	-	-	7.70

Kartons à 20 Stück		A / S	A / S	A / S	A / S	A / S
mm		100/122	100/136	100/151	120/135	120/142
Kupfer	p. St.	7.70	8.40	8.80	10.30	10.40
Zink		7.70	8.40	8.80	10.30	10.40
Cr-Ni-Stahl		9.40	9.80	-	-	-

2019 / 11

### 115-02 Übergangsstück mit Wulst

für muffenlose Rohre



		mm	A / S	A / S	A / S	A / S
			75/66	75/70	75/77	100/95
Kupfer	p. St.		7.90	7.90	7.90	9.10
Zink			7.90	7.90	7.90	9.10

### 115-21 Übergangsstück mit Reduktion



		mm	A / S	A / S	A / S	A / S
			60/72	75/85	78/92	100/110
Kupfer	p. St.		13.70	13.00	13.50	13.20
Zink			-	13.00	-	13.20

### 115-31 Schiebestück

Länge 250 mm



		mm	75/85	75/92	100/110	120/135
Kupfer	p. St.		28.00	28.00	30.00	48.00
Cr-Ni-Stahl	Übergangsstück Cr-Ni-St		26.00	33.00	36.00	Zink 45.00
Matt+ RI-Pearl	Übergangsstück Cr-Ni-St		27.00	27.00	43.00	Zink 47.00
Zink			24.50	24.50	26.50	43.00
Uginox	Übergangsstück Zink		26.00	26.00	29.00	50.00

### 115-55 Laubsieb



		Ø	75 mm	100 mm	120 mm
Cr-Ni-Stahl	p. St.		59.00	59.00	66.00

2019 / 11





**116-12 Rohrschelle, mit Holzgewinde 12 cm**

Kartons à 25 Stück	Ø	40 mm	50 mm	60 mm	75 mm	100 mm	120 mm	
	verzinkt	p. St.	-	-	-	3.80	4.00	4.30
	Kupfer		7.80	7.80	5.90	5.70	5.90	6.70
	Cr-Ni-Stahl		10.80	10.80	8.50	8.20	8.75	9.75
	Matt+ RI-Pearl		-	10.80	8.75	8.45	9.10	10.40
	Zink		6.20	6.50	5.10	4.85	5.10	5.60
	RZ vorbewittert		-	-	6.80	8.10	8.50	7.50

**116-20 Rohrschelle, mit Holzgewinde 20 cm**

Kartons à 25 Stück	Ø	40 mm	50 mm	60 mm	75 mm	100 mm	120 mm	
	verzinkt	p. St.	-	-	-	4.30	4.50	4.80
	Kupfer		*	*	7.90	6.20	6.40	8.60
	Cr-Ni-Stahl		*	*	10.80	8.70	9.25	12.50
	Matt+ RI-Pearl		-	-	10.80	8.95	9.60	-
	Zink		*	*	6.70	5.35	5.60	7.50
	RZ vorbewittert		*	*	*	*	*	*

\* auf Anfrage

2019 / 11



**116-25 Rohrschelle, mit Holzgewinde 25 cm**

Kartons à 25 Stück	Ø	40 mm	50 mm	60 mm	75 mm	100 mm	120 mm	
	verzinkt	p. St.	*	*	*	*	*	
	Kupfer		*	*	13.00	6.70	6.90	9.70
	Cr-Ni-Stahl		*	*	17.50	9.20	9.75	12.90
	Matt+ RI-Pearl		-	-	-	9.45	10.10	-
	Zink		*	*	11.50	5.85	6.10	8.30
	RZ vorbewittert		*	*	*	*	*	*

**116-30 Rohrschelle, mit Holzgewinde 30 cm**

Kartons à 25 Stück	Ø	40 mm	50 mm	60 mm	75 mm	100 mm	120 mm	
	Kupfer	p. St.	-	-	*	12.50	13.30	*
	Cr-Ni-Stahl		-	-	*	14.40	15.30	*
	Zink		-	-	*	9.20	9.60	*

**116-98 Ringschraube zu Rohrschelle M6**

Beutel à 25 Stück		
	Kupfer	1.30
	Cr-Ni-Stahl	0.90

\* auf Anfrage

2019 / 11



**116-86 Rohrschelle für Grundplatte M10**

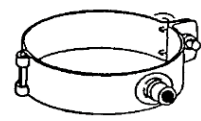

Kartons à 25 Stück	Ø	40 mm	50 mm	60 mm	75 mm	100 mm	120 mm
verzinkt	p. St.	-	-	-	5.30	5.50	5.70
Kupfer		10.00	10.00	8.15	8.35	8.60	9.10
Cr-Ni-Stahl		7.20	7.20	5.70	5.95	6.15	6.60
Matt+ RI-Pearl		-	-	5.95	6.25	6.55	-
Zink		8.30	8.30	6.90	7.10	7.20	7.60
RZ vorbewittert		*	*	*	*	*	*

**116-87 Grundplatte zu Rohrschelle M10**

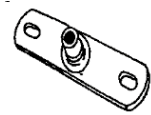

Kartons à 25 Stück		
Kupfer	p. St.	4.10
Cr-Ni-Stahl		2.55
braun plast.		2.65
grau plast.		2.65

**116-88 Gewindestange zu Rohrschelle mit Grundplatte M10**



Kartons à 10 Stück	Länge	1000 mm
Kupfer		21.00
Cr-Ni-Stahl		7.25

\* auf Anfrage

2019 / 11



**116-89 Holzgewinde M10**



Kartons à 25 Stück	Länge	120 mm	200 mm	250 mm
verzinkt	p. St.	1.30	1.60	2.60
Cr-Ni-Stahl		3.30	4.40	5.70

**116-95 Rohrschelle eckig, mit Holzgewinde 12 cm**

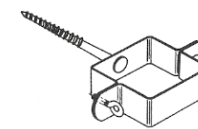

Kartons à 25 Stück		58 x 58 mm	78 x 78 mm	95 x 95 mm	120 x 120 mm
Kupfer	p. St.	9.90	10.90	13.20	15.50
Cr-Ni-Stahl		12.50	13.50	16.00	19.00
Zink		8.50	9.50	11.20	13.00

2019 / 11



**117-01 Stahlsockelrohr**

keine ungeschützten Schnittkanten, voll verzinkt bzw. beschichtet

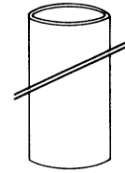

	Ø für Ø Länge	79/83 mm	104/108 mm	129/133 mm
		75 mm 1 m	100 mm 1 m	120 mm 1 m
verzinkt	p. m	42.00	44.00	65.00
braun plast.		43.00	45.00	66.00
grau plast.		43.00	45.00	66.00

	Ø für Ø Länge	79/83 mm	104/108 mm	129/133 mm
		75 mm 6 m	100 mm 6 m	120 mm 6 m
verzinkt	p. m	42.00	44.00	65.00
braun plast.		58.50	63.50	90.00
grau plast.		58.50	63.50	90.00

**117-01 Sockelrohr Kunststoff**

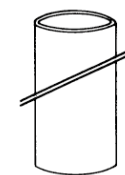

	Ø für Ø Länge	75 mm	90 mm	110 mm	140 mm
		60 mm 5 m	75 mm 5 m	100 mm 5 m	120 mm 3 m
braun	p. m	8.00	5.80	7.20	41.00
grau		8.00	5.80	7.20	41.00

2019 / 11



**118-12 Sockelrohrschelle LEICHT, Scharnier, 1 Schraube, Holzgewinde 12 cm**

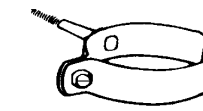

Kartons à 25 Stück	Ø Materialstärke	83 mm	90 mm	108 mm	133 mm	140 mm
		30/2	30/2	30/2	30/3	30/3
verzinkt	p. St.	3.25	3.25	3.35	4.50	-
braun plast.		4.30	4.30	4.50	6.00	7.20
grau plast.		4.30	4.30	4.50	6.00	7.20

**118-20 Sockelrohrschelle LEICHT, Scharnier, 1 Schraube, Holzgewinde 20 cm**

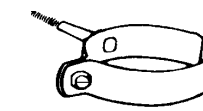

Kartons à 25 Stück	Ø Materialstärke	83 mm	90 mm	108 mm	133 mm	140 mm
		30/2	30/2	30/2	30/3	30/3
verzinkt	p. St.	3.45	3.45	3.55	4.80	-
braun plast.		4.50	4.50	4.70	6.20	9.70
grau plast.		4.50	4.50	4.70	6.20	9.70

**118-25 Sockelrohrschelle LEICHT, Scharnier, 1 Schraube, Holzgewinde 25 cm**

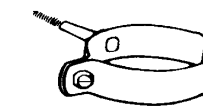

Kartons à 25 Stück	Ø Materialstärke	83 mm	90 mm	108 mm	133 mm	140 mm
		30/3	30/3	30/3	30/3	30/3
verzinkt	p. St.	-	4.70	4.80	5.20	-
braun plast.		6.10	6.10	6.20	6.80	10.50
grau plast.		6.10	6.10	6.20	6.80	10.50

**118-30 Sockelrohrschelle LEICHT, Scharnier, 1 Schraube, Holzgewinde 30 cm**

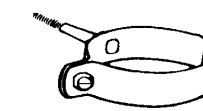

Kartons à 25 Stück	Ø Materialstärke	83 mm	90 mm	108 mm	133 mm	140 mm
			30/3	30/3		
braun plast.	p. St.	-	7.70	7.90	-	-
grau plast.		-	7.70	7.90	-	-

2019 / 11



**118-91 Sockelrohrschele für Grundplatte M10**

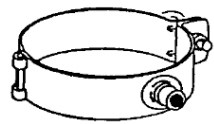

Kartons à 25 Stück	Ø	75 mm	83 mm	90 mm
verzinkt	p. St.	-	4.25	4.25
braun plast.		11.20	5.30	5.30
grau plast.		11.20	5.30	5.30

	Ø	108 mm	133 mm	140 mm
verzinkt	p. St.	4.40	5.00	6.50
braun plast.		5.40	6.40	6.40
grau plast.		5.40	6.40	6.40

**116-87 Grundplatte zu Sockelrohrschele M10**

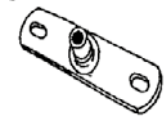

Kartons à 25 Stück		
Kupfer	p. St.	4.10
Cr-Ni-Stahl		2.55
braun plast.		2.65
grau plast.		2.65

**116-88 Gewindestange zu Sockelrohrschele mit Grundplatte M10**



Kartons à 10 Stück	Länge	1000 mm
verzinkt	p. St.	4.20
Kupfer		21.00
Cr-Ni-Stahl		7.25

2019 / 11



**119-01 Sockelrohrschele LEICHT, 2 Schrauben, Holzgewinde 12 cm**

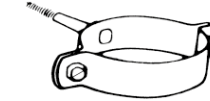

Kartons à 25 Stück	Ø	75 mm	90 mm	108 mm
	Materialstärke	20/2	20/2	20/2
braun plast.		5.40	5.40	5.50
grau plast.		5.40	5.40	5.50

**119-05 Sockelrohrschele LEICHT, 2 Schrauben, Holzgewinde 20 cm**

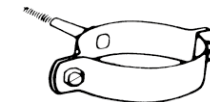

Kartons à 25 Stück	Ø	75 mm	90 mm	108 mm
	Materialstärke	20/2	20/2	20/2
braun plast.		5.60	5.60	5.70
grau plast.		5.60	5.60	5.70

2019 / 11





**119-12 Sockelrohrschelle SCHWER, mit Holzgewinde 12 cm**

mit 2 Sechskant-Schrauben

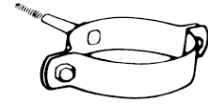

Kartons à 25 Stück	Ø	83 mm	90 mm	108 mm	133 mm
	Materialstärke	30/3	30/3	30/3	30/3
verzinkt	p. St.	6.40	6.40	6.70	7.90
braun plast.		6.40	6.40	6.70	8.30
grau plast.		6.40	6.40	6.70	7.90

**119-18 Sockelrohrschelle SCHWER, mit Holzgewinde 20 cm**

mit 2 Sechskant-Schrauben

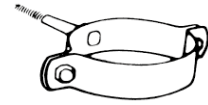

Kartons à 25 Stück	Ø	83 mm	90 mm	108 mm	133 mm
	Materialstärke	30/3	30/3	30/3	30/3
verzinkt	p. St.	6.60	6.60	6.90	7.90
braun plast.		6.60	6.60	6.90	7.90
grau plast.		6.60	6.60	6.90	8.10

**119-25 Sockelrohrschelle SCHWER, mit Holzgewinde 25 cm**

mit 2 Sechskant-Schrauben

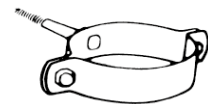

Kartons à 25 Stück	Ø	83 mm	90 mm	108 mm	133 mm
	Materialstärke	30/3	30/3	30/3	30/3
verzinkt	p. St.	9.00	9.00	9.30	-
braun plast.		9.00	9.00	9.30	-
grau plast.		9.00	9.00	9.30	-

2019 / 11



**131-11 Dunstrohreinfassung 35°**

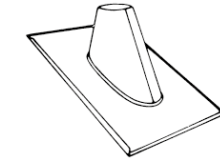

	Ø	50 mm (50°)	60 mm (50°)	75 mm	90 mm	100 mm 110 mm	120 mm
verzinkt	p. St.	-	-	29.00	-	31.00	33.00
Kupfer		61.00	61.00	52.00	62.00	57.00	60.00
Cr-Ni-Stahl		45.00	45.00	37.00	39.00	39.00	43.00
Zink		52.00	52.00	44.00	52.00	47.00	51.00
RZ vorbewittert		-	-	50.00	-	53.00	57.00
Uginox		-	-	39.00	-	41.00	43.00

	Ø	150 mm	180 mm (40°)	200 mm (40°)	250 mm (40°)	300 mm (40°)
verzinkt	p. St.	-	-	-	-	-
Kupfer		69.00	80.00	91.00	102.00	135.00
Cr-Ni-Stahl		69.00	74.00	77.00	83.00	85.00
Zink		59.00	69.00	77.00	87.00	115.00
RZ vorbewittert		-	-	-	-	-
Uginox		54.00	-	-	-	-

Langer Mantel + 20%

2019 / 11



**131-12 Dunstrohreifassung 50°**

Kartons à 10 Stück	Ø	50 mm	60 mm	75 mm	100 mm 110 mm	120 mm	150 mm
verzinkt	p. St.	-	-	-	-	-	-
Kupfer		61.00	61.00	59.00	63.00	67.00	75.00
Cr-Ni-Stahl		45.00	45.00	41.00	42.00	45.00	51.00
Zink		52.00	52.00	51.00	54.00	58.00	65.00
RZ vorbewittert		-	-	-	-	-	-
Uginox		-	-	44.00	46.00	48.00	57.00

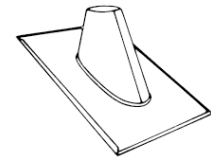

Langer Mantel + 20%

2019 / 11



**131-97 Abschlusszarge**

NW	Ø mm	60	70	80	80
passend zu Geberit	Ø mm	63	75	90	90 isol.
A / B	Ø mm	57/80	68/92	76/115	76/150
PVC schwarz	p. St.	5.90	6.10	6.20	6.60
PVC braun		5.90	6.10	6.20	6.60
PVC grau		5.90	6.10	6.20	6.60

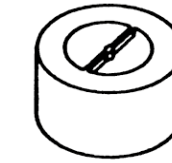

NW	Ø mm	100	100	125
passend zu Geberit	Ø mm	110/125	110 isol.	115/155
A / B	Ø mm	95/125	95/168	115/155
PVC schwarz	p. St.	6.40	6.70	6.90
PVC braun		6.40	6.70	6.90
PVC grau		6.40	6.70	6.90

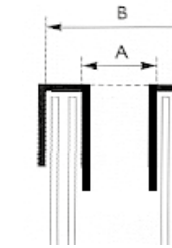

NW	Ø mm	60	70	80	80
passend zu Geberit	Ø mm	63	75	90	90 isol.
A / B	Ø mm	56/80	56/95	76/115	76/150
Kupfer	p. St.	10.20	10.20	11.20	15.60
Zink		10.20	10.20	11.20	15.60

NW	Ø mm	100	100	125
passend zu Geberit	Ø mm	110/125	110 isol.	115/155
A / B	Ø mm	95/125	95/168	115/155
Kupfer	p. St.	11.20	17.10	-
Zink		11.20	17.10	-
Cr-Ni-Stahl		19.20	-	-

2019 / 11



**131-98 Dunstrohrhut**

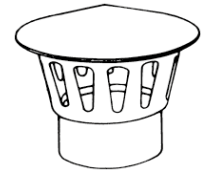

Kartons à 10 Stück	Ø	50 mm	60 mm	75 mm	100 mm	120 mm	150 mm
Kupfer	p. St.	18.90	18.90	20.00	22.70	28.60	57.50
Cr-Ni-Stahl		-	-	-	36.00	-	-
Zink		18.90	18.90	20.00	22.70	28.60	57.50

**131-99 Dunstrohrhut, mit Kragen**



Kartons à 10 Stück	Ø	75 mm 92 mm	100 mm 110 mm	120 mm 132 mm
Kupfer	p. St.	68.50	71.00	112.00
Zink		68.50	71.00	112.00

2019 / 11





**202-01 Dachfenster, einfache Verglasung, ohne Glas**

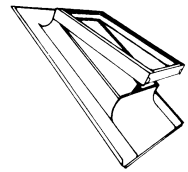

	mm	350/500	400/600	500/700	600/800
verzinkt	p. St.	-	135.00	158.00	179.00
Kupfer		169.00	154.00	180.00	259.00
Cr-Ni-Stahl		195.00	142.00	156.00	210.00
Zink		169.00	169.00	205.00	259.00
Uginox		169.00	135.00	189.00	210.00

Zuschlag für breites Tablett auf Anfrage

**202-05 Dachfenster mit Bleilaschen für Falzziegel**

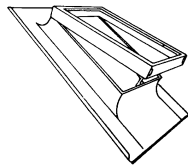

einfache Verglasung, ohne Glas

	mm	400/600	500/700	600/800
Kupfer	p. St.	220.00	275.00	350.00

**202-06 Dachfenster mit Bleilaschen für Biberschwanz-Doppeldeckung**

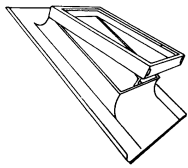

einfache Verglasung, ohne Glas

	mm	400/600	500/700	600/800
Kupfer	p. St.	295.00	350.00	425.00

Bleistreifen für Brustblech p. St. + 25.00

**202-09 Drahtglas**

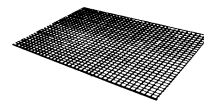

	mm	350/500	400/600	500/700	600/800
	p. St.	14.00	16.00	24.00	31.50

2019 / 11



**202-10 Dachfenster isoliert, für untergeordnete Räume, mit Holzrahmen**



	mm	350/500	400/600	500/700	600/800
Kupfer	p. St.	505.00	426.00	470.00	540.00
Cr-Ni-Stahl		540.00	540.00	590.00	630.00
Zink		505.00	426.00	470.00	540.00
Uginox		540.00	540.00	590.00	630.00

**202-16 Dachfenster isoliert, für Ziegeldächer (Wohnräume)**

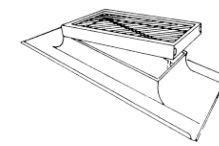

(K-Wert 1)

	mm Lichtmass	400/600 360/560	530/700 490/660	530/800 490/760
Kupfer	p. St.	499.00	545.00	590.00
Cr-Ni-Stahl		499.00	545.00	590.00
Zink		499.00	545.00	590.00

2019 / 11





**205-01 Schneefangrohr**

				3/8" 17 mm	1/2" 21 mm	3/4" 27 mm	1" 34 mm
	verzinkt	p. m	à 5.5 / 6 m	4.05	4.90	3.90	*
	Kupfer		à 5 m	-	-	*	-
	braun besch.		à 5,5 m	6.90	8.90	6.80	*
	Alu		à 6 m	-	-	-	3.90
	Cr-Ni-Stahl		à 6 m	*	*	*	6.90

\* Preise auf Anfrage

grössere Mengen auf Anfrage

**205-01 Rohrverbindung für Schnefangrohr zum Stecken**

			für Rohr	3/8"	1/2"	3/4"	1"
	PVC	p. St.		-	-	-	1.90
	Kupfer			-	-	2.75	-
	Aluman			-	-	3.20	3.20

**205-01 Endkappe für Schnefangrohr zum Stecken**

			für Rohr	3/8"	1/2"	3/4"	1"
	PVC	p. St.		-	-	-	1.00

2019 / 11



**205-03 Schneefanghaken**

			für Rohr	3/8" 30/6	1/2" 35/6	3/4" 40/6	3/4" 45/8
	verzinkt	p. St.	abgekröpft	5.80	6.60	6.90	*
	verzinkt		zum Einhängen	5.80	6.60	6.90	*
	verzinkt		gerade	*	*	11.80	*
	braun plast.		abgekröpft	7.60	8.80	7.60	*
	braun plast.		zum Einhängen	7.60	8.80	7.60	*
	braun plast.		gerade	*	*	11.80	*

\* auf Anfrage

**205-12 Schnefangrohr-Halter für Welleternit, 1 Rohr**

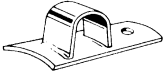
			für Rohr	3/4 - 1"
	verzinkt	p. St.		3.90
	braun plast.			5.20

**205-15 Klemmfaust für Snapfalz**

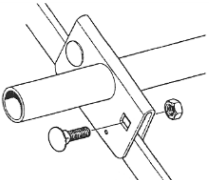
			Höhe	25 mm	38 mm
	Edelstahl	p. St.		8.90	11.30

2019 / 11

**205-19 Schneefang-Lasche für Winkelfalz-Blechdach, 1 Rohr**

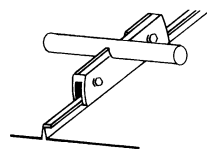
		für Rohre	1"
	Aluman	p. St.	12.50
	Alu braun besch.		auf Anfrage

**205-20 Schneefang-Lasche für Stehfalz / Snapfalz, 1 Rohr**

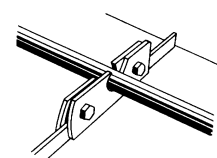
		für Rohre	1/2 - 1"
	Kupfer	p. St.	15.90
	braun besch.		8.30
	Aluman		3.90
	Cr-Ni-Stahl		8.80

**205-22 Schneefang-Lasche "TRAPEZ"**

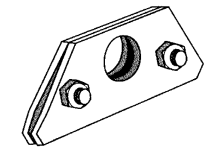
		für Rohre	3/4"
	verzinkt	p. St.	3.60
	Kupfer		auf Anfrage
	braun besch.		4.30
	Aluman		3.60

2019 / 11

**205-23 Klemmfaust**

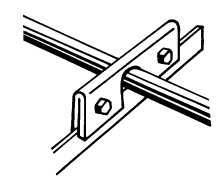
		für Rohre	3/4 - 1"
	Kupfer	p. St.	15.90
	Aluman		6.30
	Cr-Ni-Stahl		12.00

**205-24 Eis- und Schneestopp ST zum Überkletmen**

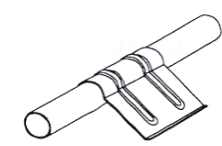
		für Rohre	3/4"	1"
	Kupfer	p. St.	3.50	3.50
	Aluman		2.30	2.30
	Cr-Ni-Stahl		3.10	3.10

**205-25 Schnee- und Eishalter, zum Schrauben REES**

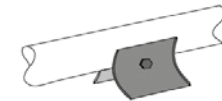
		für Rohre	1"
	Kupfer	p. St.	4.30
	Aluman		1.70
	Cr-Ni-Stahl		3.80

2019 / 11

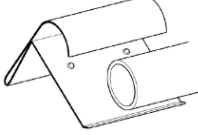

**205-26 Klemm-, Schnee- und Eisstopp, zum Einrasten**

	Höhe	25 mm	38 mm
 Kupfer 1,0 mm p. St.		4.20	4.70
Aluman 1,2 mm		2.40	2.80
Cr-Ni-Stahl 0,8 mm		3.40	3.80

**205-27 Aufstock-Element für 2 Rohre zu Artikel 2 205-19/20**

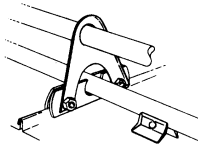
	für Rohre	1"
 Kupfer p. St.		8.50
Aluman		3.40
Cr-Ni-Stahl		5.50

**205-29 Schneefanglasche Rundkopfprofil**

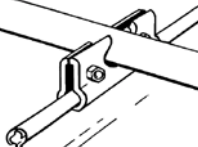
 Aluman p. St.	auf Anfrage
---	-------------

**205-32 Schneefangrohr-Halter für Leisten-/Trapezblech-Dach**

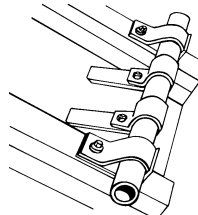
	mit Dichtungsband und 2 Schrauben 4,9 x 64 mm, für Leistendach / 5,5 x 25 mm für Trapezdach	1"
Aluman p. St.		6.00

2019 / 11

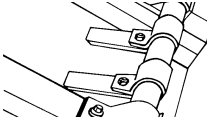

**205-33 Schnee- und Eisstopp für Leisten- / Trapezblech-Dach**

 Aluman p. St.	bis 85 mm	5.00
Aluman	bis 135 mm	5.50
Schutzkappe p. St.		0.65

**205-39 Solar-Halter für Stehfalz**

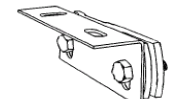
		110 mm	150 mm
 Alu p. St.		12.00	14.90
Cr-Ni-Stahl		-	23.50

**205-41 Schneefanggitter**

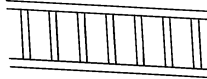
	Länge 3 m, Höhe 200 mm	L-Profil 20 x 2 mm
 verzinkt p. m		*
braun plast.		*

**205-42 Verbindungsstück für Schneefanggitter**

 verzinkt p. St.	*
braun plast.	*
* auf Anfrage	

2019 / 11



**205-45 Schneefanggitter-Halter**

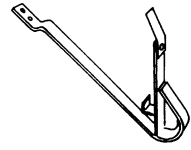

verzinkt	p. St.	abgekröpft	*
verzinkt		z. Einhängen	*
braun plast.		abgekröpft	*
braun plast.		z. Einhängen	*

**205-71 Schneefang-Rundholzstütze**

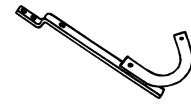

			<b>380 mm</b>
verzinkt	p. St.	abgekröpft 30/8 mm	25.00
braun plast.		abgekröpft 30/8 mm	29.00

**206-11 Trittstufen-Set für Dachneigungen bis 40° für Doppelfalz-Dach**

Breite 250 mm, inkl. verstellbaren Alu-Haltern und Befestigungsklemmen

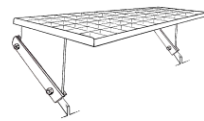

		<b>Länge</b>	<b>800 mm</b>	<b>1500 mm</b>
		Halter	2	3
Alu / verzinkt	p. St.		69.00	119.00

Für Profibleche ( Bemo, Kalzip, Rib-Roof ) auf Anfrage

**206-21 Klemmhalter für Laufstegtritte**

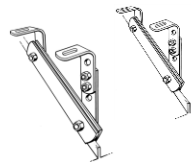

Kupfer	p. St.	*
Aluman		*

\* auf Anfrage

2019 / 11



**206-31 Standrost für Klemmhalter, mit Befestigungsschrauben**

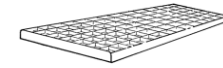

		<b>Maschen 30 x 30 mm</b>	<b>mm</b>	<b>250 x 800</b>	<b>250 x 1600</b>
verzinkt	p. St.			*	*
Kupfer				*	*

**206-35 Standrost für Klemmhalter, mit Befestigungsschrauben**

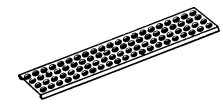

		<b>Stanzroste</b>	<b>mm</b>	<b>250 x 800</b>	<b>250 x 1500</b>
verzinkt	p. St.			*	*
Kupfer				*	*

\* auf Anfrage

2019 / 11





**220-01 Sturmklammer für Falzziegel / Biberschwanz** (Draht Ø 3.5 mm)

	verzinkt	p. St.	-30
	Kupfer		-65
	Cr-Ni-Stahl		-65

**220-02 Sturmklammer für Pfannenziegel** (Draht Ø 3.5 mm)

Verpackungseinheit 2 x 250 Stück  
gleicher Preis wie Artikel 220-01

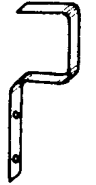

**220-06 Klammer für Falzziegel / Biberschwanz** Band

	verzinkt	p. St.	-70
	Kupfer		1.60

**220-07 Klammer für Pfannenziegel** Band

	verzinkt	p. St.	-70
	Kupfer		1.60

**220-09 Ziegel-Innenklammer**



	verzinkt	p. St.	zum Einschlagen	-30
	verzinkt		zum Einhängen	-45
	verzinkt		zum Einhängen Falz-Falz	-35

**220-11 Firstklammer** Band

	verzinkt	p. St.	-70
	Kupfer		1.40

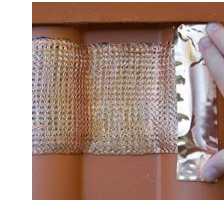

Produkt	Breite	Kupfergewicht	Wirkoberfläche	Reinigungstiefe
MOOSfree® 30	100 mm	65 g /m	0.30 m <sup>2</sup> /m	2 m
MOOSfree® 115	100 mm	250 g /m	1.70 m <sup>2</sup> /m	10 m
MOOSfree® 170	100 mm	375 g /m	2.80 m <sup>2</sup> /m	15 m

-  1.) Vlieseinlage und untere Lage des Gestricks am Anfang des Dachentmoosungsbandes mit einer Schere um ca. 2 cm kürzen.
-  2.) Einen Streifen des beiliegenden Butylbands an Stelle des herausgetrennten Vlieses auf der Unterseite von MOOSfree® aufkleben.
-  3.) Beide Trennfolien des Butylklebebandes auf ca. 40 bis 50 cm entfernen.
-  4.) MOOSfree® am Ortgangziegel beginnend ausrichten und mit der Hand leicht andrücken. Das Band nie unter Spannung verlegen.
-  5.) Mit einer ca. 4.5 cm breiten Tapezierrolle aus Hartgummi nachwalzen.
-  6.) MOOSfree® an Anschlüssen und Enden mit beiliegendem Abschlussband ankleben, um MOOSfree® zusätzlich gegen Sturm zu sichern.

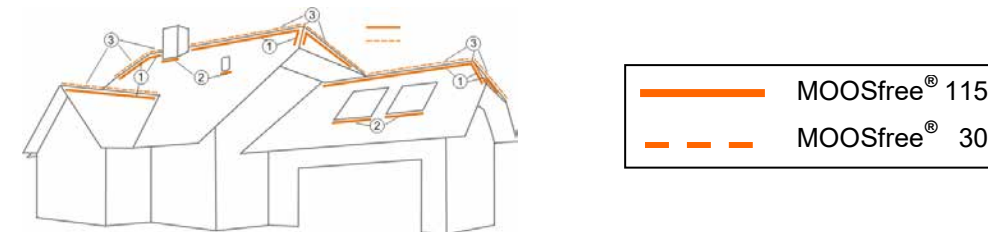

- MOOSfree® wird in der Regel unterhalb des Firstes auf der ersten Dachziegelreihe verlegt, bei Walmdächern ausserdem auf beiden Seiten des Gattes.
- Überall dort, wo der von oben kommende Wasserfluss geteilt wird, sollte ein neuer Streifen MOOSfree® 115 aufgebracht werden (z.B. unterhalb von Kaminen, Dachgauben, Dachflächenfenstern, Lüftern usw.) Dies kann entfallen, wenn die Dachgaube oder der Kamin kupferverkleidet ist.
- Für eine „perfekte“ Lösung kann auf den First zusätzlich MOOSfree® 30 aufgebracht werden.

**227-50 SPENGLER MoosFree 30**

Reinigungstiefe bis 2 m

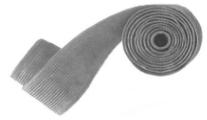

		Breite	100 mm
Kupfer	p. m	65g /m	24.50
→ 0.30 m <sup>2</sup> Kupfer Fläche			

**227-51 SPENGLER MoosFree 115**

Kupfergewebe mit Vlieseinlage, Reinigungstiefe bis 10 m

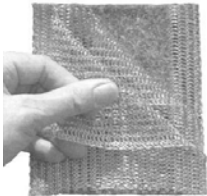

		Breite	100 mm
Kupfer mit Vlies	p. m	250g /m	49.50
→ 1.70 m <sup>2</sup> Kupfer Fläche			

**227-51 SPENGLER MoosFree 170**

Kupfergewebe mit Vlieseinlage, Reinigungstiefe bis 15 m

		Breite	100 mm
Kupfer mit Vlies	p. m	375g /m	65.00
→ 2.80 m <sup>2</sup> Kupfer Fläche			

**227-52 Butylklebeband für MoosFree**



		Breite	20 mm
	p. m		2.20

2019 / 11

**261-01 Vapozinc Trennlage**

diffusionsoffene Trennlage für Falzdächer mit Butylklebestreifen

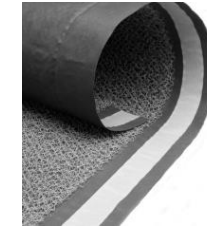

			30 x 1,4 m
sd > 0,02 m	p. m <sup>2</sup>	Rollen à 1,4 m x 30 m = 42 m <sup>2</sup>	8.90

**261-05 AIR-Z Strukturmatte**



			75 x 1,0 m
	p. m <sup>2</sup>	Rollen à 1,0 m x 75 m = 75 m <sup>2</sup>	5.90

2019 / 11

**140-03 Grosswelliges Welltablett**

Höhe und Abstand der Welle 57 x 177 mm

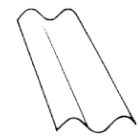

Typ 2	2 Wellen Länge mm	Länge					
		600	800	1000	1250	1500	2000
Kupfer	p. St.	31.00	43.00	51.00	66.00	77.00	107.00
Aluman		16.00	20.00	27.00	35.00	40.00	55.00
Cr-Ni-Stahl		25.00	34.00	42.00	53.00	59.00	86.00
Zink		21.00	26.00	36.00	44.00	56.00	71.00

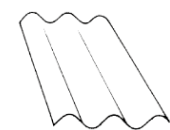

Typ 3	3 Wellen Länge mm	Länge					
		600	800	1000	1250	1500	2000
Kupfer	p. St.	46.00	61.00	74.00	96.00	112.00	148.00
Aluman		24.00	32.00	39.00	48.00	55.00	76.00
Cr-Ni-Stahl		37.00	50.00	61.00	76.00	88.00	122.00
Zink		29.00	40.00	51.00	63.00	73.00	98.00

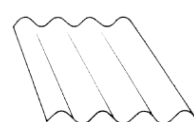

Typ 4	4 Wellen Länge mm	Länge					
		600	800	1000	1250	1500	2000
Kupfer	p. St.	62.00	79.00	99.00	125.00	143.00	194.00
Aluman		32.00	40.00	50.00	56.00	72.00	99.00
Cr-Ni-Stahl		51.00	64.00	78.00	98.00	114.00	157.00
Zink		41.00	52.00	65.00	82.00	93.00	127.00

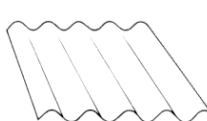

Typ 5	5 Wellen Länge mm	Länge					
		600	800	1000	1250	1500	2000
Kupfer	p. St.	79.00	100.00	122.00	157.00	178.00	241.00
Aluman		36.00	50.00	60.00	76.00	89.00	118.00
Cr-Ni-Stahl		59.00	80.00	98.00	126.00	145.00	196.00
Zink		51.00	65.00	80.00	101.00	119.00	159.00

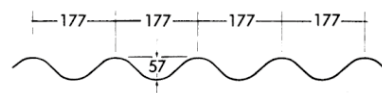

**140-05 Welleternit-Element, mit Dunstrohreifassung**

3 Wellen, Länge 1000 mm

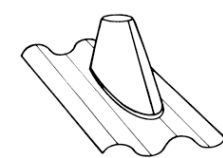

	Ø	Länge			
		75 mm	100 mm	125 mm	150 mm
Kupfer		151.00	157.00	161.00	162.00
Cr-Ni-Stahl		210.00	230.00	245.00	270.00
Zink		185.00	197.00	215.00	235.00

**140-11 Welleternit-Element, Anschluss vorne oder hinten**

6 Wellen (6 x 177 mm) Länge 1140 mm Breite 250 mm

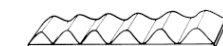

	Material	Länge	
		1140 mm	1250 mm
verzinkt	p. St.	-	-
Kupfer		106.00	-
Cr-Ni-Stahl		-	-
Zink		97.00	-

**140-16 Welleternit-Element, Anschluss seitlich**

Länge 1250 mm Breite 245 mm

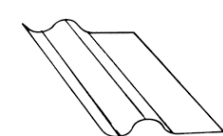

	Material	Länge	
		1250 mm	1500 mm
verzinkt	p. St.	-	-
Kupfer		75.00	-
Cr-Ni-Stahl		-	-
Zink		63.00	-



**150-50 Lüftungsband, Quadratloch 6 x 6 mm**

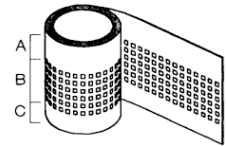

Abw.	200 mm	250 mm	330 mm
A	105 mm	140 mm	220 mm
B	70 mm	85 mm	85 mm
C	25 mm	25 mm	25 mm
Rollen	40 m	40 m	40 m

Kupfer	0.60	p. m	*	*	*	*	*
Cr-Ni-Stahl	0.50		*	*	*	*	*
Matt+ RI-Pearl	0.50		*	*	*	*	*
Zink	0.70		*	*	*	*	*
RZ vorbewittert	0.70		*	*	*	*	*
Uginox	0.50		*	*	*	*	*

\* auf Anfrage

2019 / 11



**150-60 Lochblech Tafel**

Tafeln 1000 x 2000 mm, Rundloch Ø 5 mm, Luftdurchlass ca. 47%

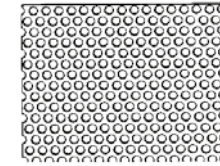

Kupfer	p. m <sup>2</sup>	0.60	54.50
Aluman		1.00	11.70
Cr-Ni-Stahl		1.00	34.50
Alu plast. braun/weiss		0.70	18.90
Alu plast. braun/anthra		0.70	18.90
Zink		1.00	35.00

\* auf Anfrage

**150-61 SPENGLER-Lochblech 75**

Breite 1000 mm, Quadrat-Lochung 6 x 6 mm, Luftdurchlass 75%, sehr gute Stabilität



Massstab 1 : 1

		Rolle à	12 m (12 m <sup>2</sup> )	30 m (30 m <sup>2</sup> )
Kupfer	p. m	1.00	53.50	-
Alu		1.00	-	12.90

**150-63 Rauten Lochband**

Breite 1000 mm, Luftdurchlass 63%

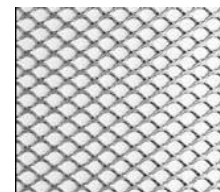

		Rolle à	20 m (20 m <sup>2</sup> )
Alu	p. m	0.80	16.50

**150-65 Lochblech-Band**

Breite 1000 mm, Rundloch Ø 5 mm, Luftdurchlass 47%

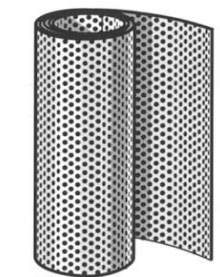

		Rolle à	20 m (20 m <sup>2</sup> )
Kupfer	p. m	0.60	52.50
Aluman		1.00	11.70
Alu plast. braun/weiss		0.70	18.90
Alu plast. braun/anthra		0.70	18.90

2019 / 11



**150-75 Hinterlüftungsband für Kamine**



Breite	90 mm
Cr-Ni-Stahl	p. m
	7.90

**150-76 Abroller für Hinterlüftungsband**



	p. St.	129.00
--	--------	--------

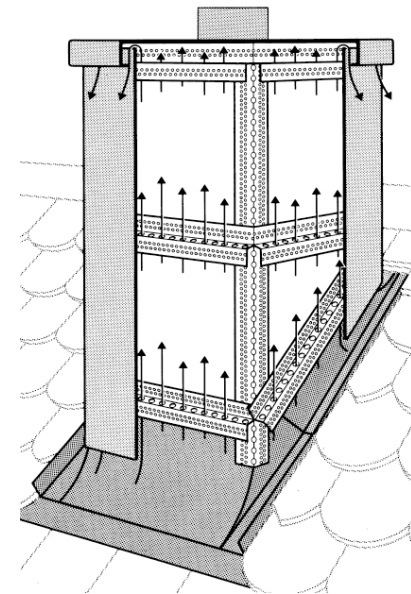

2019 / 11

**160-11 Ventilations-Einsatz, mit Wetterlamellen und Fliegengitter**

Stutzenlänge 50 mm



	Stutzen Ø	75 mm	95 mm	115 mm	135 mm	145 mm
Kupfer	p. St.	14.00	16.00	18.00	19.00	20.00
Aluman		11.00	12.00	13.00	14.00	15.00

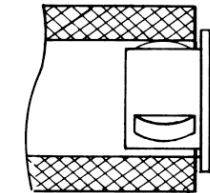

	Stutzen Ø	155 mm	175 mm	190 mm	220 mm	245 mm
Kupfer	p. St.	21.00	21.00 <sup>+</sup>	22.00 <sup>+</sup>	105.00	115.00
Aluman		16.00	-	17.00 <sup>+</sup>	50.00	60.00

	Stutzen Ø	275 mm	295 mm	310 mm
Kupfer	p. St.	125.00	133.00	145.00
Aluman		60.00	80.00	92.00

**160-16 Ventilations-Einsatz eckig, mit Wetterlamellen und Fliegengitter**

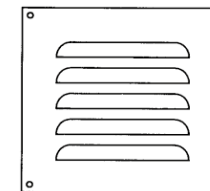

	Höhe	Breite	140 mm	140 mm	140 mm	150 mm
Kupfer	p. St.		14.00	17.00	21.00 <sup>+</sup>	21.00
Aluman			11.00	13.00	15.00 <sup>+</sup>	15.00

+ solange Vorrat

2019 / 11

**160-21 Wetterschutzgitter 200 x 200 - 1000 x 1000 mm**



**Gitter Richtpreise**

Gitter in Kupfer									
p. St.									
Höhe:	Breite:	300	400	500	600	700	800	900	1000
bis 300	203.00	218.00	230.00	243.00	259.00	270.00	342.00	358.00	
400	222.00	239.00	251.00	263.00	278.00	298.00	378.00	394.00	
500	251.00	270.00	290.00	311.00	330.00	354.00	458.00	489.00	
600	290.00	311.00	330.00	346.00	365.00	390.00	510.00	537.00	
700	330.00	346.00	365.00	390.00	413.00	442.00	569.00	601.00	
800	358.00	378.00	394.00	425.00	458.00	517.00	641.00	668.00	
900	390.00	413.00	450.00	517.00	569.00	616.00	744.00	796.00	
1000	442.00	477.00	521.00	585.00	645.00	724.00	855.00	919.00	

Wetterschutzgitter in Aluminium									
p. St.									
Höhe:	Breite:	300	400	500	600	700	800	900	1000
bis 300	86.00	92.00	98.00	103.00	110.00	114.00	145.00	152.00	
400	95.00	101.00	107.00	111.00	118.00	127.00	161.00	167.00	
500	107.00	114.00	123.00	132.00	140.00	150.00	194.00	207.00	
600	123.00	132.00	140.00	146.00	155.00	165.00	216.00	228.00	
700	140.00	146.00	155.00	165.00	175.00	187.00	241.00	254.00	
800	152.00	161.00	167.00	180.00	194.00	219.00	272.00	283.00	
900	165.00	175.00	190.00	219.00	241.00	261.00	315.00	337.00	
1000	187.00	202.00	221.00	248.00	273.00	307.00	362.00	389.00	

Gitter in Cr-Ni-Stahl oder Zink									
p. St.									
Höhe:	Breite:	300	400	500	600	700	800	900	1000
bis 300	217.00	233.00	246.00	261.00	278.00	289.00	367.00	383.00	
400	237.00	256.00	269.00	282.00	298.00	319.00	405.00	422.00	
500	269.00	289.00	310.00	333.00	354.00	379.00	490.00	523.00	
600	310.00	333.00	354.00	371.00	391.00	417.00	546.00	575.00	
700	354.00	371.00	391.00	417.00	442.00	474.00	609.00	643.00	
800	383.00	405.00	422.00	456.00	490.00	553.00	686.00	715.00	
900	417.00	442.00	482.00	553.00	609.00	660.00	797.00	852.00	
1000	474.00	511.00	558.00	626.00	691.00	775.00	915.00	984.00	

Grössere Dimensionen auf Anfrage

Mengenrabatt auf Anfrage

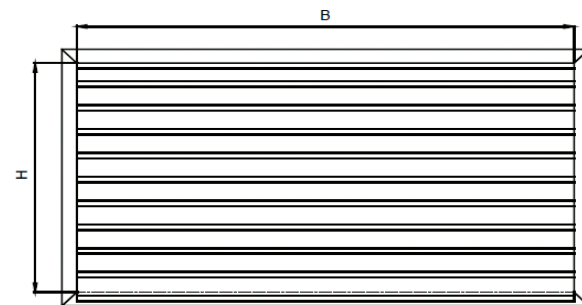
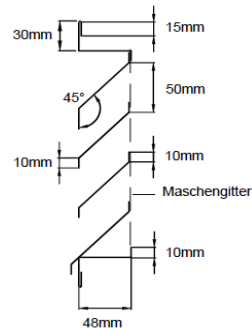

**181-01 BIRD-EX 1-reihig für Simstiefe 50 mm**

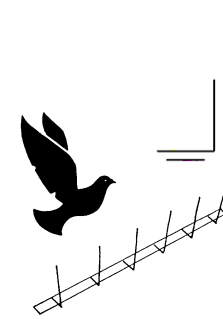

max. Abstand vom Sims 20 mm, vom Gebäude 100 mm  
zum Aufnieten oder Aufkleben mit Klebeband 1.1 x 19 mm

Länge 500 mm, Breite 25 mm, Höhe 135 mm

Cr-Ni-Stahl	p. St.	11.50
-------------	--------	-------

**181-11 Clip zur Befestigung am Rinnenwulst**

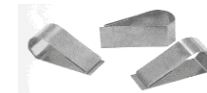

Cr-Ni-Stahl	p. St.	1.50
-------------	--------	------

**181-02 BIRD-EX 2-reihig für Simstiefe 100 mm**

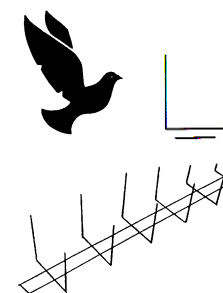

Länge 500 mm, Breite 50 mm, Höhe 135 mm

Cr-Ni-Stahl	p. St.	11.50
-------------	--------	-------

grössere Mengen auf Anfrage

**181-03 BIRD-EX 3-reihig für Simstiefe 150 mm**

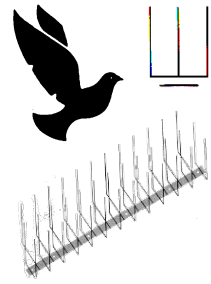

Länge 480 mm      Breite 90 mm

Cr-Ni-Stahl	p. St.	13.00
-------------	--------	-------

**181-04 BIRD-EX 4-reihig für Simstiefe 200 mm**

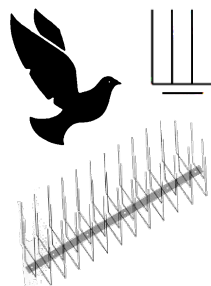

Länge 480 mm      Breite 130 mm

Cr-Ni-Stahl	p. St.	15.50
-------------	--------	-------

**181-21 Vogelabwehrprofil zum Anieten**

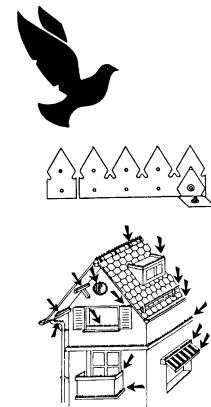

40 x 1000 mm

Kupfer	p. m	24.00
--------	------	-------

Cr-Ni-Stahl		24.00
-------------	--	-------

grössere Mengen auf Anfrage

2019 / 11

**Vogelabwehr BIRD-EX**

**BIRD-EX aus rostfreiem Edelstahl**

Die Leisten sind vorgelocht. Dadurch können sie schnell und einfach geklebt, geschraubt oder genietet werden.

Die biegsamen Spitzen-Leisten können ganz leicht um runde oder sonstige gebogene Bereiche montiert werden.



**Die verschiedenen Typen**

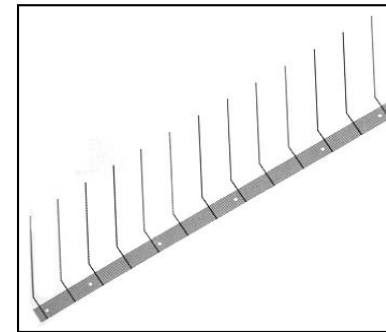

BIRD-EX 1-reihig

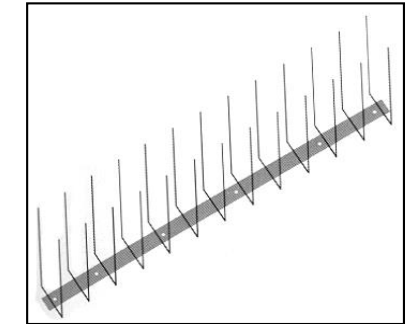

BIRD-EX 2-reihig

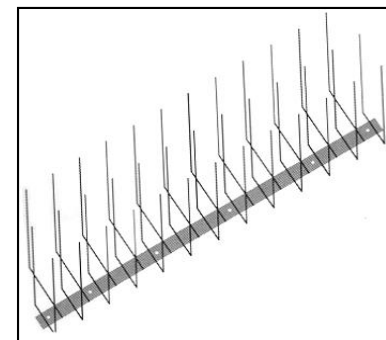

BIRD-EX 3-reihig

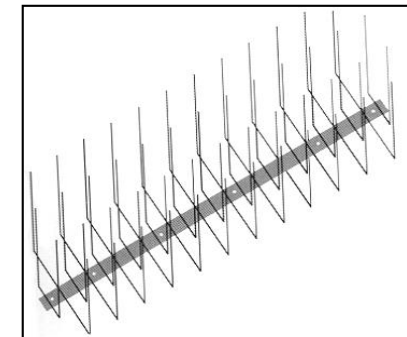

BIRD-EX 4-reihig

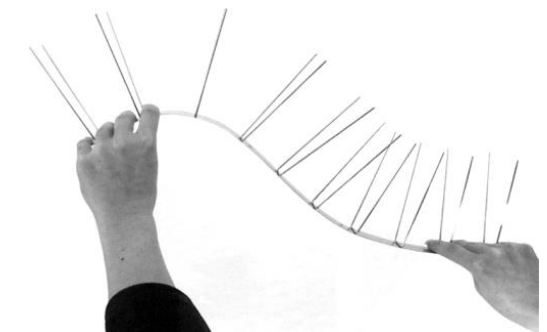
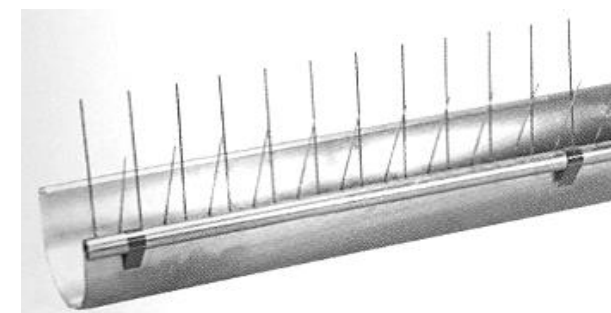

1  
2  
3  
4  
5  
6  
7  
8  
9  
10  
11  
12



## BIRD-EX Spanndraht-System

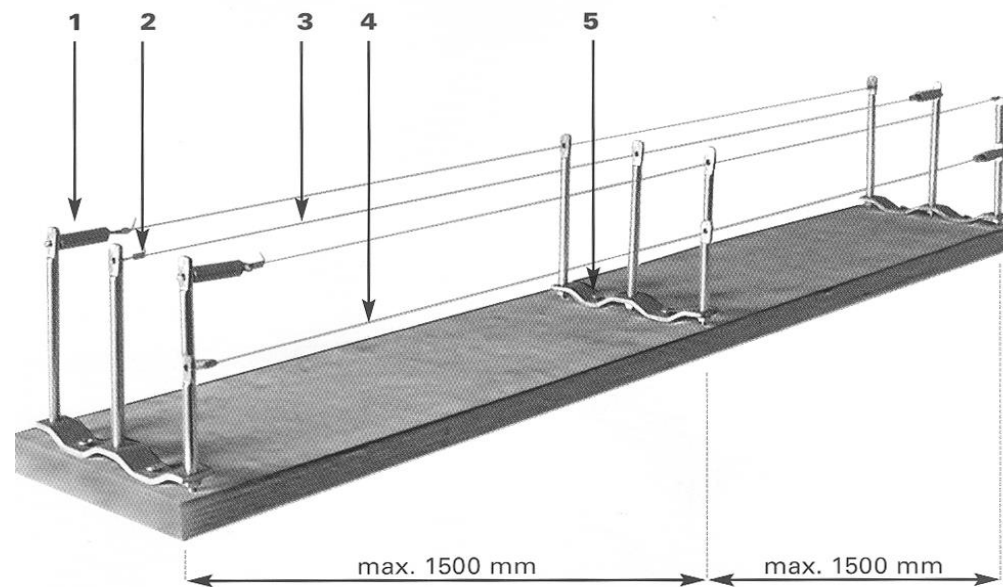

### Bilderläuterung:

1. Feder
2. Drahtverbinder
3. Spanndraht
4. Unterflugschutz
5. Edelstahlhalter



### Montageanleitung PAS-Spanndrahtsystem

- PAS-Edelstahlhalter nach schützender Breite auswählen, Abstand zur Wand maximal 40 mm, zur Vorderkante maximal 10 mm. Bei Mauerkronen etc. beidseitig maximal 10 mm Abstand zur Kante.
- PAS-Edelstahlhalter befestigen, je nach Untergrund Dübel mit Schraube, Blechschraube oder Nieten.
- Abstand der weiteren Halter max. alle 1,5 m.
- Spanndraht auf einer Seite mit Schlaufe und Drahtverbinder verpressen, überstehendes Drahtende auf 1 cm kürzen und umbiegen.
- Spanndraht durch das entsprechende Loch des nächsten Halters durchfädeln.
- Feder in dritten Halter einhängen, Spanndraht mit Schlaufe und Drahtverbinder an der Feder befestigen, leicht spannen, Drahtverbinder verpressen, überstehendes Drahtende auf 1 cm kürzen und umbiegen.
- Auf der waagrechten Ebene Feder wechselseitig montieren (siehe Foto/Zeichnung)

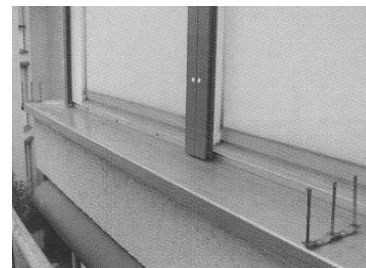
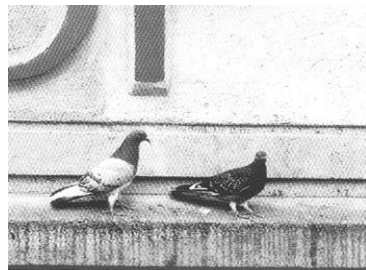





**132-01 Drehkaminhut "John" eckig**

mit patentierter Hochleistungsachse, Kragen 50 mm



		mm	160/160	180/180	200/200	220/220	240/240	250/250
Kupfer	p. St.	190.00	198.00	210.00	225.00	240.00	240.00	
		150.00	160.00	170.00	190.00	210.00	210.00	
Cr-Ni-Stahl	p. St.	265.00	265.00	295.00	330.00	380.00	520.00	
		235.00	235.00	255.00	290.00	340.00	470.00	

**132-02 Drehkaminhut "John" rund**

rund, mit patentierter Hochleistungsachse, mit Sicke



		Ø	105 mm	125 mm	150 mm	160 mm	180 mm	200 mm
Kupfer	p. St.	125.00	135.00	145.00	150.00	155.00	160.00	
		99.00	109.00	120.00	125.00	135.00	145.00	
Cr-Ni-Stahl	p. St.	180.00	195.00	225.00	255.00	275.00	310.00	
		160.00	175.00	198.00	215.00	255.00	290.00	

**Zuschlag für:**

Kragen rund	20 mm	+ 10%
Kragen rund	50 mm	+ 20%
Tablett eckig	50 mm	+ 15%



**132-05 Drehkaminhut "John" mit Zarge**

mit patentierter Hochleistungsachse, mit Abschlusszarge Isolation 80 mm



**Zargenlänge 100 mm**

		NW Ø	125 mm	150 mm	175 mm	200 mm
Kupfer	p. St.	300 mm	265.00	275.00	290.00	298.00
		300 mm	225.00	230.00	240.00	250.00
Cr-Ni-Stahl	p. St.	400 mm	330.00	345.00	420.00	455.00
		400 mm	275.00	290.00	345.00	380.00

**Zargenlänge 1000 mm**

		NW Ø	125 mm	150 mm	175 mm	200 mm
Kupfer	p. St.	300 mm	360.00	380.00	395.00	415.00
		300 mm	310.00	320.00	350.00	355.00
Cr-Ni-Stahl	p. St.	400 mm	425.00	475.00	580.00	650.00
		400 mm	380.00	405.00	495.00	550.00



**132-11 Aspirateur**

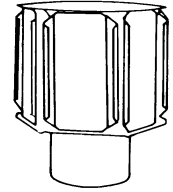

Ø	100 mm	125 mm	150 mm
Höhe	180 mm	216 mm	216 mm
max. Ø	160 mm	192 mm	192 mm

	p. St.	100 mm	125 mm	150 mm
Kupfer		65.50	74.50	114.50
Cr-Ni-Stahl		65.50	74.50	114.50
Zink		60.50	66.50	106.50

**132-12 Lüftungshut IDEAL**

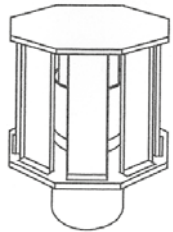

Ø	80 mm	100 mm	120 mm	125 mm	150 mm
---	-------	--------	--------	--------	--------

Kupfer	p. St.	73.00	73.00	73.00	75.00	80.00
Cr-Ni-Stahl		64.00	64.00	64.00	67.00	80.00
Zink		70.00	70.00	70.00	72.00	77.00

Ø	180 mm	200 mm	250 mm	300 mm
---	--------	--------	--------	--------

Kupfer	p. St.	85.00	97.00	104.00	109.00
Cr-Ni-Stahl		84.00	95.00	101.00	105.00
Zink		81.00	93.00	99.00	104.00

**132-13 Lüftungshut IDEAL mit Abschlusszarge, Rohr 200 mm lang, für Isolation 25 cm**

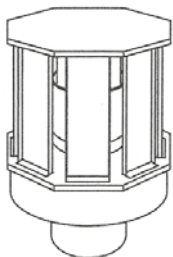

Ø	80 mm	100 mm	120 mm	125 mm	150 mm
Zarge	140 mm	160 mm	180 mm	185 mm	210 mm

Kupfer	p. St.	97.00	97.00	97.00	99.00	105.00
Cr-Ni-Stahl		85.00	85.00	85.00	87.00	101.00
Zink		93.00	93.00	93.00	95.00	99.00

Ø	180 mm	200 mm	250 mm	300 mm
Zarge	240 mm	260 mm	310 mm	360 mm

Kupfer	p. St.	109.00	121.00	129.00	134.00
Cr-Ni-Stahl		105.00	115.00	122.00	126.00
Zink		104.00	115.00	123.00	128.00



**132-14 Kaminaufsatz SAIRLIFT**

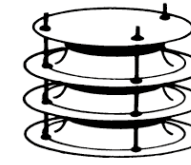

Ø	100 mm	125 mm	150 mm	175 mm	200 mm	250 mm
---	--------	--------	--------	--------	--------	--------

Kupfer	p. St.	202.00	218.00	228.00	235.00	249.00	279.00
Cr-Ni-Stahl		166.00	174.00	183.00	195.00	204.00	222.00
Alu blank		103.00	131.00	137.00	141.00	145.00	162.00
Alu braun		144.00	172.00	177.00	184.00	191.00	217.00

**132-15 Anschluss-Stutzen verstellbar**

rund

Ø	100 mm	125 mm	150 mm	175 mm	200 mm	250 mm
Bereich	100-124	125-149	150-174	175-199	200-249	250-299

Cr-Ni-Stahl	p. St.	40.00	44.00	44.00	47.00	47.00	56.00
Alu blank		23.00	32.00	32.00	36.00	36.00	43.00

eckig

Ø	100 mm	125 mm	150 mm	175 mm	200 mm	250 mm
Bereich		110-125	126-150	151-175	176-200	201-250

Cr-Ni-Stahl	p. St.	40.00	44.00	44.00	47.00	47.00	56.00
Alu blank		23.00	32.00	32.00	36.00	36.00	43.00

**132-16 Zarge für 80 mm Isolation**

Innen	100 mm	125 mm	150 mm	175 mm	200 mm	250 mm
Aussen	280 mm	305 mm	330 mm	355 mm	380 mm	430 mm

Kupfer	p. St.	105.00	105.00	105.00	115.00	115.00	140.00
Cr-Ni-Stahl		105.00	105.00	105.00	115.00	115.00	140.00



**132-21 Kaminaufsatz "AIROSTAR", rund**

		Ø	120 mm	150 mm	180 mm	200 mm
	Kupfer	p. St.	137.00	141.00	150.00	171.00
	Cr-Ni-Stahl		133.00	137.00	146.00	166.00
		Ø			250 mm	300 mm
	Kupfer	p. St.			185.00	205.00
	Cr-Ni-Stahl				179.00	199.00

Masstabelle in mm

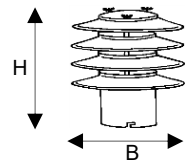

	H	B
Ø 120 mm	370	190
Ø 150 mm	370	230
Ø 180 mm	370	280
Ø 200 mm	370	310
Ø 250 mm	410	385
Ø 300 mm	460	430

**132-22 Kaminaufsatz "FÖHN-X", rund**

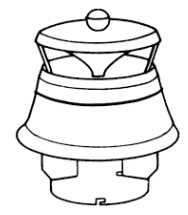
		Ø	120 mm	150 mm	180 mm	200 mm
	Kupfer	p. St.	210.00	216.00	234.00	242.00
	Cr-Ni-Stahl		204.00	210.00	227.00	235.00
		Ø			250 mm	300 mm
	Kupfer	p. St.			282.00	324.00
	Cr-Ni-Stahl				274.00	314.00

Masstabelle in mm

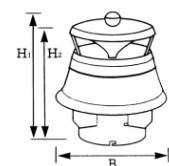

	H1	H2	B
Ø 120 mm	505	440	305
Ø 150 mm	505	440	305
Ø 180 mm	535	470	370
Ø 200 mm	545	480	370
Ø 250 mm	560	495	440
Ø 300 mm	580	515	490



**132-27 Ansatzteil eckig zu AIROSTAR / FÖHN-X / KING**

		<u>Eckig 395 mm x 395 mm</u>			
		innen Ø	120 mm	150 mm	180 mm
		aussen	395 x 395	395 x 395	395 x 395
	Kupfer	p. St.	61.00	61.00	61.00
	Cr-Ni-Stahl		59.00	59.00	59.00
		innen Ø	200 mm	250 mm	300 mm
		aussen	395 x 395	495 x 495	495 x 495
	Kupfer	p. St.	61.00	75.00	75.00
	Cr-Ni-Stahl		59.00	73.00	73.00

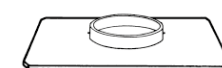
		<u>Eckig 1000 x 1000 mm</u>			
		innen Ø	120 mm	150 mm	180 mm
		aussen	1000 x 1000	1000 x 1000	1000 x 1000
	Kupfer	p. St.	178.00	178.00	178.00
	Cr-Ni-Stahl		173.00	173.00	173.00
		innen Ø	200 mm	250 mm	300 mm
		aussen	1000 x 1000	1000 x 1000	1000 x 1000
	Kupfer	p. St.	178.00	178.00	178.00
	Cr-Ni-Stahl		173.00	173.00	173.00

1  
2  
3  
4  
5  
6  
7  
8  
9  
10  
11  
12



**132-28 Ansatzteil eckig, mit Stützen rund**

Stützenlänge 150 mm

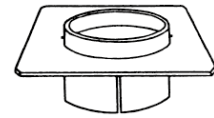

		innen Ø	120 mm	150 mm	180 mm
		Tablett	395 x 395	395 x 395	395 x 395
		Stützen Ø	115 mm	145 mm	175 mm
Kupfer	p. St.		105.00	105.00	105.00
Cr-Ni-Stahl			97.00	97.00	97.00

		innen Ø	200 mm	250 mm	300 mm
		Tablett	395 x 395	495 x 495	495 x 495
		Stützen Ø	195 mm	245 mm	295 mm
Kupfer	p. St.		105.00	119.00	119.00
Cr-Ni-Stahl			97.00	111.00	111.00

**132-29 Ansatzteil eckig, mit Stützen eckig**

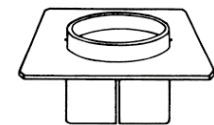

		innen Ø	120 mm	150 mm	180 mm
		Tablett	395 x 395	395 x 395	395 x 395
		Stützen Ø	115 x 115	145 x 145	175 x 175
Kupfer	p. St.		115.00	115.00	115.00
Cr-Ni-Stahl			105.00	105.00	105.00

		innen Ø	200 mm	250 mm	300 mm
		Tablett	395 x 395	495 x 495	495 x 495
		Stützen Ø	195 x 195	245 x 245	295 x 295
Kupfer	p. St.		115.00	129.00	129.00
Cr-Ni-Stahl			105.00	119.00	119.00

2019 / 11



**132-30 Ansatzteil mit Stützen und Zarge für Isolation 80 mm**

Stützenlänge 150 mm, Zargenhöhe 100 mm

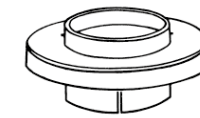

		für Ø	120 mm	150 mm	180 mm
		aussen Ø	295 mm	325 mm	355 mm
Kupfer	p. St.		199.00	199.00	210.00
Cr-Ni-Stahl			175.00	175.00	199.00

		für Ø	200 mm	250 mm	300 mm
		aussen Ø	375 mm	425 mm	475 mm
Kupfer	p. St.		210.00	210.00	210.00
Cr-Ni-Stahl			199.00	199.00	199.00

2019 / 11





**132-31 Kaminhut SIRIUS rund mit Sicke**

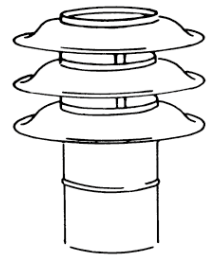

	Ø	100 mm	125 mm	150 mm	160 mm	175 mm
Kupfer	p. St.	192.00	192.00	215.00	220.00	235.00
Aluman		122.00	122.00	129.00	131.00	137.00
Cr-Ni-Stahl		170.00	170.00	185.00	190.00	205.00
Zink		192.00	192.00	215.00	220.00	235.00

	Ø	200 mm	225 mm	250 mm	300 mm	350 mm
Kupfer	p. St.	245.00	270.00	285.00	340.00	375.00
Aluman		143.00	146.00	149.00	172.00	203.00
Cr-Ni-Stahl		225.00	235.00	250.00	298.00	325.00
Zink		245.00	270.00	285.00	340.00	375.00

**132-32 Kaminhut SIRIUS eckig mit Bord 50 mm**

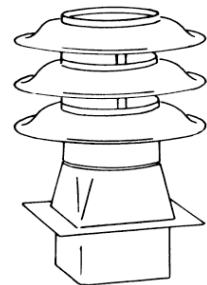

	mm	125/125	160/160	180/180	200/200	220/220
Kupfer	p. St.	215.00	250.00	275.00	295.00	315.00
Aluman		133.00	149.00	160.00	170.00	178.00
Cr-Ni-Stahl		190.00	220.00	240.00	255.00	270.00
Zink		215.00	250.00	275.00	295.00	315.00

	mm	250/250	280/280	300/300	320/320	350/350
Kupfer	p. St.	350.00	398.00	430.00	475.00	535.00
Aluman		190.00	210.00	220.00	240.00	270.00
Cr-Ni-Stahl		310.00	350.00	375.00	410.00	465.00
Zink		350.00	398.00	430.00	475.00	535.00



**132-33 Kaminhut SIRIUS mit Abschlusszarge 100 mm für Isolation 80 mm**

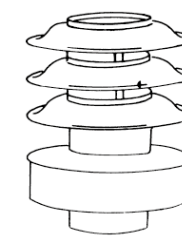

	Nennweite Ø Zarge	125 mm 300 mm	150 mm 325 mm	175 mm 350 mm	200 mm 375 mm
Kupfer	p. St.	295.00	330.00	350.00	370.00
Aluman		184.00	206.00	218.00	230.00
Cr-Ni-Stahl		265.00	295.00	310.00	330.00
Zink		295.00	330.00	350.00	370.00

	Nennweite Ø Zarge	225 mm 400 mm	250 mm 425 mm	300 mm 475 mm	350 mm 525 mm
Kupfer	p. St.	395.00	420.00	490.00	560.00
Aluman		245.00	261.00	305.00	350.00
Cr-Ni-Stahl		350.00	380.00	440.00	498.00
Zink		395.00	420.00	490.00	560.00

**132-34 Kaminhut SIRIUS mit Abschlusszarge 100 mm für Isolation 50 mm**

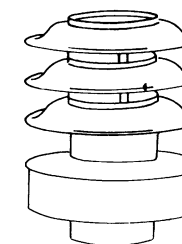

	Nennweite Ø Zarge	125 mm 240 mm	150 mm 265 mm	175 mm 290 mm	200 mm 315 mm
Kupfer	p. St.	295.00	330.00	350.00	370.00
Aluman		184.00	206.00	218.00	230.00
Cr-Ni-Stahl		265.00	295.00	310.00	330.00
Zink		295.00	330.00	350.00	370.00

	Nennweite Ø Zarge	225 mm 340 mm	250 mm 365 mm	300 mm 415 mm	350 mm 465 mm
Kupfer	p. St.	395.00	420.00	490.00	560.00
Aluman		245.00	261.00	305.00	350.00
Cr-Ni-Stahl		350.00	380.00	440.00	498.00
Zink		395.00	420.00	490.00	560.00

Sirius mit Zargen 500 / 1000 mm auf Anfrage



**132-35 Kaminhut SIRIUS, ohne Rohrstützen**

		Ø	100 mm	125 mm	150 mm	160 mm	175 mm
	Kupfer	p. St.	172.00	172.00	195.00	198.00	215.00
	Aluman		116.00	116.00	123.00	125.00	129.00
	Cr-Ni-Stahl		155.00	155.00	165.00	170.00	185.00
	Zink		172.00	172.00	195.00	198.00	215.00

		Ø	200 mm	225 mm	250 mm	300 mm	350 mm
	Kupfer	p. St.	225.00	245.00	260.00	310.00	335.00
	Aluman		136.00	138.00	141.00	163.00	192.00
	Cr-Ni-Stahl		198.00	210.00	225.00	270.00	295.00
	Zink		225.00	245.00	260.00	310.00	335.00

2019 / 11

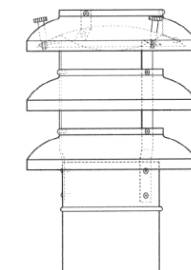

**132-41 Kaminhut BELLATRIX rund mit Sicke**

		Ø	100 mm	125 mm	150 mm	160 mm	175 mm
	Kupfer	p. St.	192.00	192.00	215.00	220.00	235.00
	Aluman		122.00	122.00	129.00	131.00	137.00
	Cr-Ni-Stahl		170.00	170.00	185.00	190.00	205.00

		Ø	200 mm	225 mm	250 mm	300 mm	350 mm
	Kupfer	p. St.	245.00	270.00	285.00	340.00	375.00
	Aluman		143.00	146.00	149.00	172.00	203.00
	Cr-Ni-Stahl		220.00	235.00	250.00	295.00	345.00

**132-42 Kaminhut BELLATRIX eckig mit Bord 50 mm**

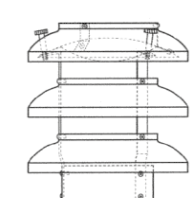
		mm	125/125	160/160	180/180	200/200	220/220
	Kupfer	p. St.	215.00	250.00	275.00	295.00	315.00
	Aluman		133.00	149.00	160.00	170.00	178.00
	Cr-Ni-Stahl		190.00	220.00	240.00	255.00	275.00

		mm	250/250	280/280	300/300	320/320	350/350
	Kupfer	p. St.	350.00	398.00	430.00	475.00	535.00
	Aluman		190.00	210.00	220.00	240.00	270.00
	Cr-Ni-Stahl		310.00	345.00	375.00	410.00	465.00

2019 / 11

**132-44 Kaminhut BELLATRIX mit Abschlusszarge**

100 mm hoch für Isolation 50 mm

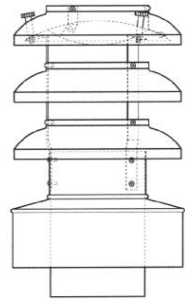

	Nennweite Ø Zarge	125 mm 240 mm	150 mm 265 mm	175 mm 290 mm	200 mm 315 mm
Kupfer	p. St.	295.00	330.00	350.00	370.00
Aluman		184.00	206.00	218.00	230.00
Cr-Ni-Stahl		265.00	295.00	310.00	330.00

	Nennweite Ø Zarge	225 mm 340 mm	250 mm 365 mm	300 mm 415 mm	350 mm 465 mm
Kupfer	p. St.	395.00	420.00	490.00	560.00
Aluman		245.00	261.00	305.00	350.00
Cr-Ni-Stahl		355.00	385.00	440.00	498.00

**BELLATRIX mit Zargen 500/1000/1500 mm**

**auf Anfrage**

2019 / 11

**132-45 Kaminhut BELLATRIX ohne Rohrstützen**

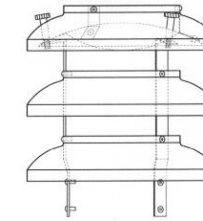

	Ø	100 mm	125 mm	150 mm	160 mm	175 mm
Kupfer	p. St.	172.00	172.00	195.00	198.00	215.00
Aluman		116.00	116.00	123.00	125.00	129.00
Cr-Ni-Stahl		155.00	155.00	170.00	175.00	185.00

	Ø	200 mm	225 mm	250 mm	300 mm	350 mm
Kupfer	p. St.	225.00	245.00	260.00	310.00	335.00
Aluman		136.00	138.00	141.00	163.00	192.00
Cr-Ni-Stahl		198.00	210.00	225.00	265.00	290.00

**132-46 Maschengitter zu SIRIUS / BELLATRIX**

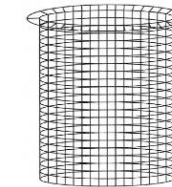

Maschen 16 x 16 mm

	Ø	125 mm	150 mm	175 mm	200 mm
Cr-Ni-Stahl	p. St.	16.00	20.00	23.00	26.00

  

	Ø	225 mm	250 mm	300 mm	350 mm
Cr-Ni-Stahl	p. St.	29.00	30.00	35.00	44.00

2019 / 11

**132-51 CASTOR Lamellenhut CRK**

mit Schutzgitter aus Cr-Ni-Stahl

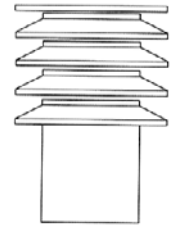

	Ø	100 mm	125 mm	150 mm	180 mm	200 mm	250 mm
Kupfer	p. St.	190.00	205.00	230.00	310.00	345.00	485.00
Aluman		140.00	152.00	170.00	225.00	250.00	360.00
Cr-Ni-Stahl		180.00	195.00	210.00	285.00	310.00	430.00
Zink		190.00	205.00	230.00	310.00	345.00	425.00

	Ø	300 mm	350 mm	400 mm	450 mm	500 mm	600 mm
Kupfer	p. St.	620.00	740.00	850.00	1'150.00	1'350.00	1'700.00
Cr-Ni-Stahl		535.00	645.00	740.00	950.00	1'200.00	1'500.00

**132-52 CASTOR Lamellenhut CT**

mit Schutzgitter aus Cr-Ni-Stahl, Standrohr 250 mm, mit Abschlusstrichter

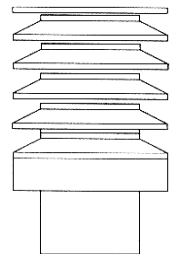

	Ø	100 mm	125 mm	150 mm	180 mm	200 mm	250 mm
Kupfer	p. St.	210.00	225.00	255.00	315.00	375.00	595.00
Aluman		155.00	170.00	185.00	222.00	275.00	440.00
Cr-Ni-Stahl		270.00	285.00	325.00	398.00	475.00	625.00
Zink		210.00	225.00	255.00	315.00	375.00	595.00

Weitere Grössen auf Anfrage

**132-58 Entlüfter ANTARES AMT, mit Abschlusstrichter**

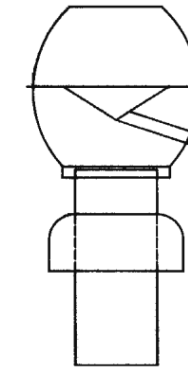

Standrohr 250 mm

	Trichter Ø	80 mm 140 mm	100 mm 160 mm	125 mm 185 mm	150 mm 210 mm
Kupfer	p. St.	72.00	81.00	95.50	129.00
Cr-Ni-Stahl		82.00	90.50	110.00	140.00
Aluman		52.30	57.00	66.50	86.50
Zink		86.00	94.50	113.00	146.00

Standrohr 500 mm

Kupfer	p. St.	90.00	100.00	117.00	157.00
Cr-Ni-Stahl		97.00	108.00	131.00	166.00
Aluman		63.00	68.00	80.00	104.00
Zink		96.00	106.00	126.00	165.00

Standrohr 1000 mm

Kupfer	p. St.	97.00	107.00	125.00	168.00
Cr-Ni-Stahl		104.00	115.00	139.00	176.00
Aluman		67.00	72.00	85.00	111.00
Zink		102.00	112.00	135.00	176.00

**132-59 Entlüfter ANTARES AOT, mit Sicke**

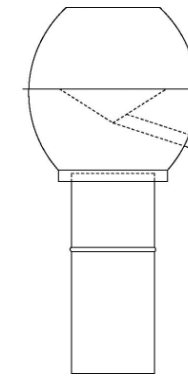

Standrohr 200 mm

	Ø	80 mm	100 mm	125 mm	150 mm
Kupfer	p. St.	64.00	71.00	84.00	112.00
Cr-Ni-Stahl		74.00	82.00	99.00	126.00
Aluman		48.00	52.00	62.00	82.00
Zink		70.00	76.00	89.00	119.00

Technische Daten / Masse

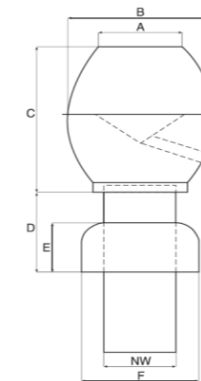

Nennweite	A	B	C	D	E	F
Ø 80	90	160	180	120	72	140
Ø 100	110	198	216	120	72	160
Ø 125	145	236	265	120	72	185
Ø 150	172	286	308	120	72	210
Ø 160	172	286	308	120	72	222



**132-61 Abluftregenhut rund, Standrohr 1000 mm**

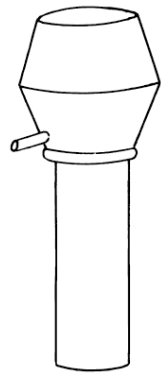

	Ø	100 mm	125 mm	150 mm	175 mm	200 mm	250 mm
Kupfer	p. St.	150.00	180.00	240.00	270.00	290.00	445.00
Aluman		115.00	139.00	164.00	175.00	185.00	275.00
Cr-Ni-Stahl		198.00	210.00	235.00	265.00	298.00	420.00
Zink		162.00	184.00	238.00	261.00	282.00	420.00

	Ø		300 mm	350 mm	400 mm	450 mm
Kupfer	p. St.		520.00	615.00	765.00	870.00
Aluman			290.00	325.00	390.00	445.00
Cr-Ni-Stahl			520.00	650.00	798.00	920.00
Zink			495.00	585.00	730.00	830.00

	Ø	500 mm	600 mm	700 mm	800 mm	900 mm	1000 mm
Kupfer	p. St.	1'140.00	1'390.00	1'610.00	2'150.00	2'530.00	2'910.00
Aluman		510.00	680.00	835.00	865.00	1'070.00	1'510.00
Cr-Ni-Stahl		1'110.00	1'360.00	1'590.00	1'890.00	2'270.00	2'680.00
Zink		1'080.00	1'330.00	1'540.00	2'050.00	2'410.00	2'770.00

Aufpreis für Isolation 25 mm auf Anfrage  
Minderpreis für Standrohr 500 mm abzgl. 3%

**132-62 Abluftregenhut eckig, Standrohr 500 mm**

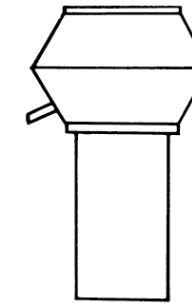

	mm	200/200	250/250	300/300	350/350	400/400
Kupfer	p. St.	560.00	690.00	735.00	865.00	950.00
Aluman		305.00	310.00	340.00	398.00	445.00
Cr-Ni-Stahl		545.00	620.00	720.00	860.00	990.00

	mm	450/450	500/500	600/600	800/800	1000/1000
Kupfer	p. St.	1'075.00	1'190.00	1'340.00	2'160.00	2'710.00
Aluman		545.00	610.00	880.00	1'350.00	1'690.00
Cr-Ni-Stahl		1'100.00	1'220.00	1'430.00	2'250.00	2'610.00

Aufpreis für Standrohr 1000 mm + 12%  
Aufpreis für Isolation 25 mm + 12%

Weitere Grössen auf Anfrage

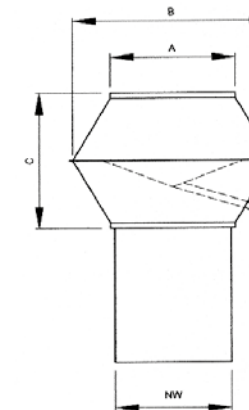

NW:	A	B	C
200/200	230	390	330
250/250	280	460	365
300/300	330	530	405
350/350	380	610	460
400/400	430	690	505
450/450	480	760	560
500/500	530	840	580
600/600	630	970	630
800/800	830	1220	745
1000/1000	1030	1520	805

**132-63 Abluftregenhut mit Abschlusstrichter, Standrohr 250 mm**



	Ø	100 mm	125 mm	150 mm	175 mm	200 mm	250 mm
Kupfer	p. St.	150.00	180.00	240.00	275.00	298.00	510.00
Aluman		113.00	137.00	167.00	183.00	190.00	329.00
Cr-Ni-Stahl		210.00	235.00	250.00	280.00	310.00	480.00
Zink		175.00	210.00	256.00	287.00	320.00	485.00

	Ø	300 mm	350 mm	400 mm	450 mm	500 mm
Kupfer	p. St.	580.00	665.00	798.00	890.00	1'110.00
Aluman		363.00	395.00	449.00	497.00	555.00
Cr-Ni-Stahl		550.00	675.00	810.00	920.00	1'080.00
Zink		550.00	635.00	765.00	845.00	1'060.00

Aufpreis für Standrohr 500 mm + 7%  
 Aufpreis für Isolation 25 mm auf Anfrage

**Weitere Grössen auf Anfrage**

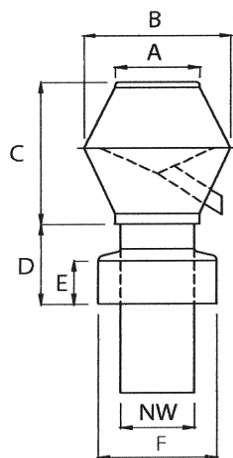

NW:	A	B	C	D	E	F
100	115	200	210	120	70	160
125	150	255	250	120	70	185
150	170	295	290	120	70	210
175	200	335	330	120	70	235
200	230	375	360	120	70	260
250	280	460	440	120	70	310
300	330	525	500	120	70	360
350	380	625	580	120	70	410
400	430	710	610	120	70	460
450	480	780	660	120	70	510
500	530	850	840	120	70	560

2019 / 11

**Dachhaube für Mehrzweckentlüftung bestehend aus drei Komponenten:**

- Dachsockel mit Auflagerand, innen 1" isoliert.
- Zwischenblech mit Einzelstützen.
- Regenhaube für Vertikalausblas mit allseitig abgeschirmten Abluftrohren.

**Aufriss 1-reihig**

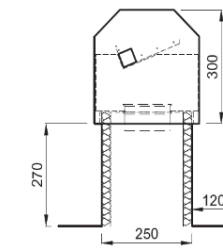

**Aufriss 2-reihig**

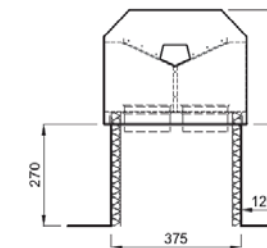

**Seitenansicht**

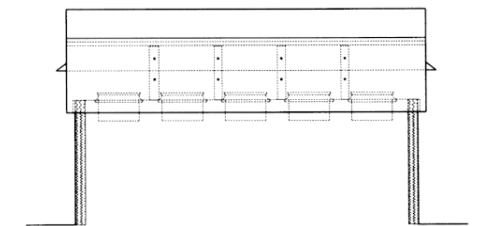

**1-reihig**

Anzahl Stützen	Sockelmasse Breite x Länge
1	250 x 250 mm
2	250 x 360 mm
3	250 x 520 mm
4	250 x 680 mm
5	250 x 840 mm
6	250 x 1000 mm
7	250 x 1160 mm
8	250 x 1320 mm

Sollten paarweise 150 mm Lüftungsstützen zum Einsatz kommen, verändern sich das Anfangs- und Achsmass

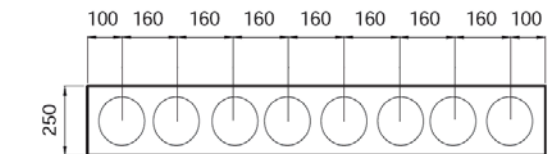

**2-reihig**

Anzahl Stützen pro Reihe	Sockelmasse Breite x Länge
2+2	375 x 375 mm
3+3	375 x 520 mm
4+4	375 x 680 mm
5+5	375 x 840 mm
6+6	375 x 1000 mm
7+7	375 x 1160 mm
8+8	375 x 1320 mm

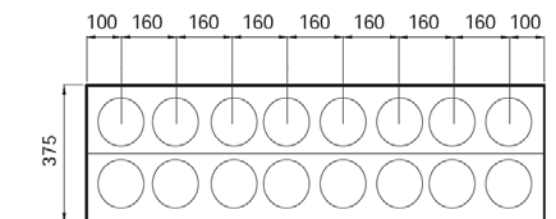

**Varianten:**

**Typ HF**  
für Flachdach

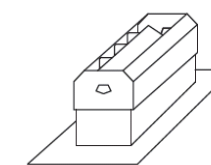

**Typ HQ**  
für Steildach  
parallel zum First

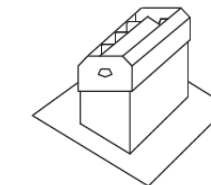

**Typ HL**  
für Steildach  
parallel zum Ort

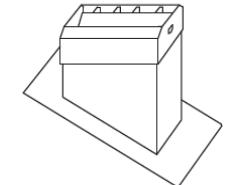

## Bestell-Fax für Ventilations-Hauben

**Typ HQ**  
für Steildach  
parallel zum First

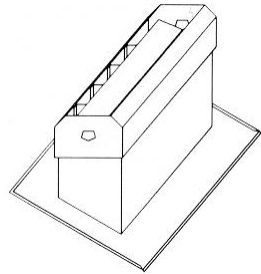

- 1-reihig
- 2-reihig

**Material:**  
**Matériel:**

- Kupfer
- Uginox
- .....

**Typ HL**  
für Steildach  
parallel zum Ort

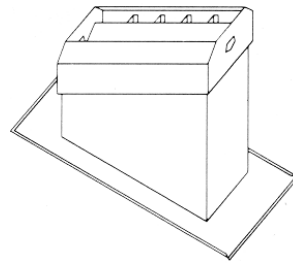

- 1-reihig
- 2-reihig

- Cr-Ni-Stahl
- Zink blank

**Typ HF**  
für Flachdach

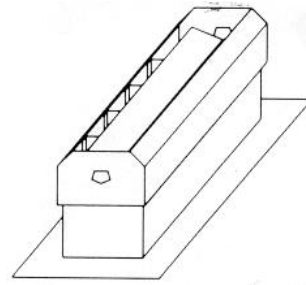

- 1-reihig
- 2-reihig

**Dachschräge:** ..... Grad von der Waagrechten

**Ziegeltyp:** .....

- Sanitärstützen:**
- Ø 80/ 90 mm
  - Ø 100/110 mm
  - Ø 120/130 mm

- Lüftungsstützen:**
- Ø 100 mm
  - Ø 125 mm
  - Ø 150 mm

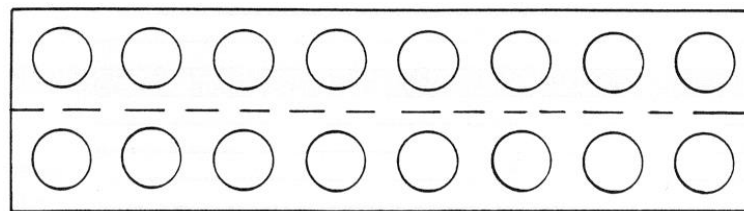

Traufe Typ HQ

Traufe Typ HL

**Bestellmenge:** .....

**Liefertermin:** .....

**Lieferadresse:** .....

**Bemerkungen:** .....

**Datum:** .....

**Fax:** .....

**Unterschrift:** .....

**Telefon:** .....



**501-03 Universal-Klemme SPD**

als Falz-, Kreuz- oder Abzweigklemme

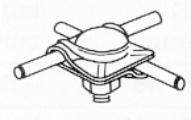

Kartons à 50 Stück		Ø	6-10 mm	
Kupfer blank	p. St.	37 x 37 mm (3 mm) mit VA Schraube 8 x 30 mm	3.60	H
Cr-Ni-Stahl			3.10	H

**501-03 Universal-Klemme AF**

als Falz-, Kreuz- oder Abzweigklemme



Kartons à 50 Stück		Ø	6-10 mm	
Kupfer blank	p. St.	37 x 37 mm (3 mm) mit VA Schraube 8 x 30 mm	5.31	AF 275.050.000 H
Cr-Ni-Stahl			4.68	AF 270.048.000 H

**501-05 Abzweigklemme AF**



Kartons à 50 Stück		Ø	6-7 mm	8 mm	
Kupfer blank	p. St.		5.67	7.11	AF 125.152.604 H AF 125.153.605 H
Kupfer verzinkt			6.34	7.87	AF 125.164.604 H AF 125.165.605 H

**501-10 Bodendrahtklemme AF**



Kartons à 25 Stück		Ø	6-10 mm	
Kupfer blank	p. St.		14.98	AF 275.027.114 H
Kupfer verzinkt			17.91	AF 275.027.025 H

**501-15 Dachrinnen-Wulstklemme AF**



Kartons à 50 Stück		Ø	6-10 mm	
Kupfer blank	p. St.		8.86	AF 285.102.000 H
Cr-Ni-Stahl			9.45	AF 280.100.000 H

2019 / 11



**501-18 Dachrinnen-Wulstklemme SPD**

Kartons à 50 Stück		Ø	6-11 mm	
Kupfer blank	p. St.		5.50	H
Kupfer vernickelt			5.80	H

**501-21 Schneefangklemme 3/8 - 1 " AF**

Kartons à 25 Stück		Ø	4-10 mm	
Cr-Ni-Stahl	p. St.		11.74	AF 280.103.000 H

**501-29 Kreuz- und Parallelverbindung Band / Draht AF**

Kartons à 10 Stück		Ø	8-10 mm	
Kupfer	p. St.		18.22	AF 265.002.420 H

**501-33 Parallelklemme für 2 Armierungseisen AF**

Kartons à 50 Stück		Ø	6-22 mm	
Eisen	p. St.		4.81	AF 281.085.000

**501-34 Kreuzverbindung für Drähte und Band AF**

Kartons à 25 Stück		Ø	6-8 mm	
Kupfer blank	p. St.	2-teilig	11.11	AF 275.045.404 H

**501-36 Schraubklemme bis Ø 10 mm AF**

Kartons à 25 Stück		Ø	10-22 mm	
Temperguss	p. St.		14.71	AF 281.077.037

2019 / 11





**501-69 Seilanschluss- Set 800 mm AF**



Kartons à 5 Stück	Ø	6-8 mm		
Cr-Ni-Stahl	p. St.	34.24	AF 280.103.010	

**501-74 Anschlussgarnitur für bestehende Gebäude AF**



Kartons à 5 Stück	Ø	8-10 mm		
Cr-Ni-Stahl	p. St.	41.31	AF 281.104.000	

**501-45 Klemmplatte mit Schraube zu Anschlussgarnitur M10 x 25 AF**



Kartons à 25 Stück	Ø	6-8 mm		
Cr-Ni-Stahl	p. St. für 1 Draht	3.73	AF 285.099.025	

**501-81 Anschlussklemme für Stahlträger SPD**



Kartons à 25 Stück	Ø	6-10 mm		
verzinkt	p. St. für Stahlprofile 1-12 mm	8.50		

**501-86 Anschlussklemme für Stahlträger SPD**



Kartons à 25 Stück	Ø	6-10 mm		
verzinkt	p. St. für Stahlprofile 1-12 mm	9.50		

**501-88 Anschlussklemme für Stahlträger / Liftschienen AF**



Kartons à 10 Stück	Ø	6-10 mm		
Cr-Ni-Stahl	p. St. für Stahlprofile 10-30 mm	15.07	AF 270.050.000 H	
Cr-Ni-Stahl	p. St. für Stahlprofile 2-16 mm	13.95	AF 270.050.001 H	

**501-90 Kontaktklemme für Profilschienen AF**



Kartons à 50 Stück	Ø	6-10 mm		
Cr-Ni-Stahl	p. St. T-Nutenbreite 17,2 mm	6.97	AF 260.062.051 H	

2019 / 11



**502-03 Messtrennmuffe mit Imbusschrauben AF**



Kartons à 25 Stück	Ø	6-11 mm		
Cr-Ni-Stahl	p. St.	10.03	AF 270.025.003 H	

**502-06 Messtrennmuffe mit Imbusschrauben AF**



Kartons à 25 Stück	Ø	6-8 mm		
Kupfer	p. St.	8.91	AF 275.017.000 H	

**502-11 Messtrennmuffe mit Imbusschrauben BS SPD**

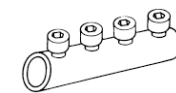

Kartons à 20 Stück	Ø	6-8 mm		
Kupfer	p. St.	6.10	H	
Cr-Ni-Stahl		6.10	H	

**502-51 UP Messtrennstelle AF**



Verpackungseinheit 4 Stück	<b>Grösse</b>	<b>170 x 115 x 95 mm</b>	
Kunststoff / Deckel Cr-Ni-Stahl	p. St.	63.40	AF 276.030.000

**502-61 Revisionstüre SPD**

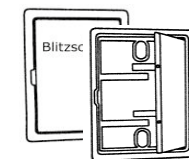

Verpackungseinheit 5 Stück	<b>Grösse Einbaumass</b>	<b>180 x 230 mm 155 x 205 mm</b>	
Cr-Ni-Stahl	p. St.	35.50	

2019 / 11



**502-71 Unterflurkasten mit Deckel SPD**

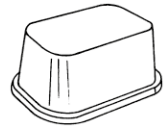

Verpackungseinheit 2 Stück **220 x 135 x 125 mm**

Guss schwarz	p. St.	1 kg	69.00
--------------	--------	------	-------

**503-01 Kabelschuh mit Befestigungsschraube AF**



Kartons à 50 / 25 Stück **Ø 6 mm 8 mm**

Kupfer blank	p. St.	10.93	16.47	AF 275.030.553 / 275.031.555 H
--------------	--------	-------	-------	--------------------------------

Kupfer verzinkt		11.79	17.28	AF 275.030.526 / 275.031.527 H
-----------------	--	-------	-------	--------------------------------

**503-02 Kabelschuh ohne Befestigungsschraube AF**



Kartons à 50 / 25 Stück **Ø 6 mm 8 mm**

Kupfer blank	p. St.	9.22	13.50	AF 275.030.554 / 275.031.556 H
--------------	--------	------	-------	--------------------------------

Kupfer verzinkt		9.63	14.80	AF 275.030.004 / 275.031.027 H
-----------------	--	------	-------	--------------------------------

**503-21 Anschluss-Set AF**



mit 7 Bechernieten

Kartons à 20 Stück **Ø 6-7 mm**

Kupfer blank	p. St.	13.81	AF 275.060.000 H
--------------	--------	-------	------------------

Cr-Ni-Stahl		15.39	AF 270.090.000 H
-------------	--	-------	------------------

**503-31 Blech-Anschluss mit Klemmplatte AF**



mit 4 Bechernieten

Kartons à 10 Stück **Ø 6-10 mm**

Kupfer blank	p. St.	8.01	AF 275.062.000 H
--------------	--------	------	------------------

Cr-Ni-Stahl		8.37	AF 270.092.000 H
-------------	--	------	------------------



**504-05 Kontaktbride variabel SPD**

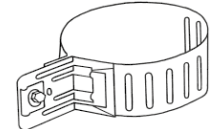

für Ablaufrohre Ø 50-120 mm, stufenweise alle 5 mm verstellbar

Kartons à 25 Stück **Ø 6-10 mm**

Kupfer	p. St.	12.90	H
--------	--------	-------	---

Cr-Ni-Stahl		9.90	H
-------------	--	------	---

**504-05 Kontaktbride variabel AF**



für Ablaufrohre, stufenweise alle 5 mm verstellbar

Kartons à 25 Stück **Ø 70 - 120**

Kupfer	p. St.	17.05	AF 285.103.000 H
--------	--------	-------	------------------

Cr-Ni-Stahl		12.91	AF 280.101.000 H
-------------	--	-------	------------------

**504-08 Drahthalterbride für Ablaufrohre, variabel AF**



für Ablaufrohre Ø 70 - 120 mm, stufenweise alle 5 mm verstellbar

Kartons à 50 Stück **Ø 6-9 mm**

Kupfer	p. St.	7.60	AF 245.045.751
--------	--------	------	----------------

Cr-Ni-Stahl		5.85	AF 240.053.751
-------------	--	------	----------------

**504-15 Kontaktbride für Gasrohre, variabel, 3/8 - 2", AF**



Klemmbereich Ø 17,2 - 60,3 mm

Kartons à 25 Stück **Ø 6-9 mm**

Kupfer verzinkt	p. St.	14.94	AF 285.037.214 H
-----------------	--------	-------	------------------

**504-18 Bandrohrschelle AF**



Mit Anschlussklemme für Längs- und Querverdrahtung

Kartons à 10 Stück **Ø 6-8 mm**

Cr-Ni-Stahl	p. St.	bis 180 mm	9.36	AF 280.105.004
-------------	--------	------------	------	----------------



**505-05 Erdleiterträger mit Holzschraube AF**



Kartons à 20 Stück	Ø 6-8 mm
Kupfer vernickelt	p. St. Schraube 5 x 40 mm Ø 14 mm 7.11 AF 245.027.011

**505-06 Erdleiterträger DUPLO SPD**

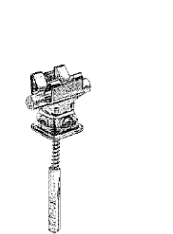

mit Nageldübel 5 x 60 mm, inkl. Distanzstück 18 mm

Kartons à 100 Stück	Ø 6 mm
Kupfer	p. St. 1.60
Cr-Ni-Stahl	1.60

**505-07 Erdleiterträger mit Bohrung AF**



Kartons à 20 Stück	Ø 6-8 mm
Kupfer vernickelt	p. St. Bohrung 5,2 mm 7.15 AF 245.030.017

**505-11 Erdleiterträger QUADRO mit Holzschraube AF**



Kartons à 50 Stück	Ø 6-10 mm
Cr-Ni-Stahl	p. St. Schraube 5 x 40 mm 1.89 AF 240.005.000

**505-12 Erdleiterträger QUADRO mit Nageldübel AF**



Kartons à 50 Stück	Ø 6-10 mm
Cr-Ni-Stahl	p. St. 6 x 40 mm 2.20 AF 240.011.000

**505-13 Erdleiterträger QUADRO mit Bohrung 6,5 mm AF**



Kartons à 50 Stück	
Cr-Ni-Stahl	p. St. 1.66 AF 240.001.000

2019 / 11



**505-17 Grundplatte zu QUADRO 10 mm AF**



Kartons à 50 Stück	
Kunststoff grau	p. St. 0.81 AF 247.001.000

**505-18 Distanzstück zu QUADRO 10 mm AF**



Kartons à 50 Stück	
Kunststoff grau	p. St. 0.81 AF 247.002.000

**506-04 Dachleitungsstütze für Ziegel QUADRO AF**



Kartons à 50 Stück	Länge 400 mm	Ø 6-10 mm
Cr-Ni-Stahl	4.95	AF 220.024.000

**506-10 Dachleitungsstütze für Flacheternit AF**



Kartons à 50 Stück	Ø 6-8 mm
Kupfer	p. St. 1.39 AF 225.006.003

**506-13 First- und Gratleitungshalter für Flacheternit QUADRO AF**



Kartons à 50 Stück	Ø 6-10 mm
Cr-Ni-Stahl	p. St. 5.49 AF 220.018.002

**506-20 Leitungsträger für Flachdach, Kunststoff mit Betonfüllung SPD**

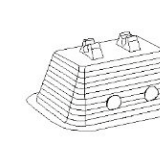

Kartons à 20 Stück	Ø 6-8 mm
Kunststoff	p. St. 1.85 (226.017.005)

**506-24 Flachdachdurchführung AF**



Höhe 300 mm, Ø 12 mm	Ø 6-12 mm
Cr-Ni-Stahl	p. St. 98.14 AF 220.223.003
Kupfer T-Kabel 50 mm²	Länge 650 mm und 2 Klemmer 23.13 AF 220.223.002

2019 / 11



**506-35 Firstziegelklammer Uniflex DUPLO SPD**



Kartons à 50 Stück	Ø	6 mm	
Kupfer	p. St.		6.90
Cr-Ni-Stahl			5.90

**506-38 First- und Gratleitungshalter QUADRO AF**



Kartons à 50 Stück	Ø	6-10 mm	
Kupfer	p. St.		9.18 AF 225.018.002

**507-04 BS-Drahtbride für Welleternit, kurz SPD**

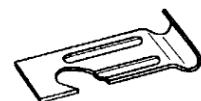

Kartons à 50 Stück	Ø	6 mm	50 mm
Kupfer	p. St.		1.10
Zink			1.10

**507-05 BS-Drahtbride für Welleternit, lang SPD**



Kartons à 50 Stück	Ø	6 mm	80 mm
Kupfer	p. St.		1.10

**507-06 BS-Drahtbride für Flacheternit SPD**

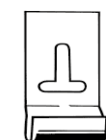

Kartons à 50 Stück	Ø	6 mm	
Kupfer	p. St.		1.30

**507-09 BS-Bride für Biberschwanzziegel, schmale Form SPD**

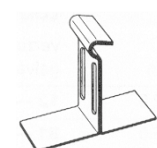

Kartons à 100 Stück		
Kupfer	p. St.	1.85

**507-13 Dachleistungsstütze QUADRO, für alle Ziegel AF**



Kartons à 50 Stück	Ø	6-10 mm	
Kupfer	p. St.	Halter Cr-Ni-Stahl schwarz	4.68 AF 225.021.000
Cr-Ni-Stahl			3.64 AF 220.025.000

2019 / 11



**507-15 BS-Drahtbride für Firstziegel SPD**



Kartons à 50 Stück		
Kupfer	p. St.	1.60
Zink		1.60

**507-91 Zange für BS Briden SPD**



	p. St.	85.00
--	--------	-------

**507-00 BS-Drahtbride für Falzziegel SPD**

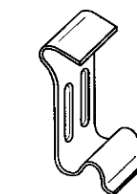

Kartons à 100 Stück		
Kupfer	p. St.	1.10
Zink		1.10

**507-01 BS-Bride für Pfannenziegel SPD**

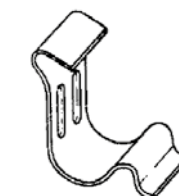

Kartons à 100 Stück		
Kupfer	p. St.	1.10

2019 / 11



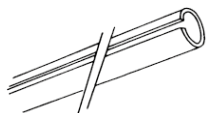

**508-01 Blitzschutzrohr SPD**

				Rohr Ø	1/2"	
	Cr-Ni-Stahl	p. St.	Länge	150 cm	12.50	(250.002.000)
				450 cm	37.50	(250.003.000)

**508-06 Bride für Blitzschutzrohr an Sockelrohrschelle SPD**

Kartons à 25 Stück

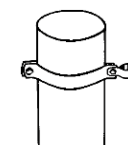
	Cr-Ni-Stahl	p. St.		2.40
---	-------------	--------	--	------

**508-07 Befestigungsrohrschelle für Blitzschutzrohre an Sockelrohrschelle AF**

isoliert, mit Kunststoff-Einlage für Stahlrohre

Kartons à 25 Stück



Cr-Ni-Stahl	p. St.	5.35	AF 250.017.000
-------------	--------	------	----------------

nicht isoliert, für Rohre PE

Kartons à 25 Stück



Cr-Ni-Stahl	p. St.	4.59	AF 250.018.000
-------------	--------	------	----------------

**508-08 Befestigungsrohrschelle 1/2" HG Ø 6 x 50 mm AF**

Kartons à 25 Stück

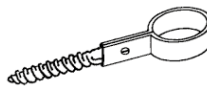

Cr-Ni-Stahl	p. St.	4.90	AF 250.016.000
-------------	--------	------	----------------

2019 / 11



**508-11 Blitzschutzprofil U-Profil AF**



Kartons à 6 Stück				15 x 15 x 15 mm		
Cr-Ni-Stahl	p. St.	Länge	150 cm	14.67	AF 250.009.674	

**508-12 Befestigungsbride für Blitzschutzprofil beidseitig SPD**

Kartons à 50 Stück



Cr-Ni-Stahl	p. St.	1.30
-------------	--------	------

**508-13 Befestigungsbride für Blitzschutzprofil einseitig SPD**

Kartons à 50 Stück



Cr-Ni-Stahl	p. St.	1.30
-------------	--------	------

**510-01 Rohrschelle 1/2", mit Holzgewinde und 2 Schrauben SPD**

Kartons à 50 Stück



		Länge	8 cm	12 cm
verzinkt	p. St.	2.50	2.50	

**510-05 Rohrschelle 1/2", mit Schraube 6 x 35 mm und Dübel AF**

Kartons à 25 Stück

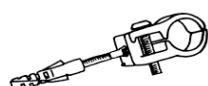

Alu	p. St.	4.27	AF 252.004.202
-----	--------	------	----------------

**510-25 Blitzschutz-Draht**

		Ø	6 mm 250 g / m 25 kg	8 mm 135 g / m 20 kg	8 mm 450 g / m 25 kg
Rollen à					
Kupfer	p. kg		*	-	*
Kupfer verzinkt			*	-	*
Aluminium			-	*	-



\* auf Anfrage

2019 / 11

**520-02 Erdungselektrode AF**

	1 Ring à 20 kg (à ca. 21 m <sup>1</sup> )	Ø	50 mm <sup>2</sup>		
	Kupfer	p. St.	21.64	AF 265.017.552	

**520-01 Vortriebsspitze AF**

		Ø	17 mm		
	Stahl	p. St.	10.57	AF 261.002.020	

**520-03 Führungsrohr für Seilquerschnitt von 50 mm<sup>2</sup> AF**

		Ø	17 mm		
	Stahl	p. St.	Länge 100 cm	10.89	AF 261.003.513

**520-04 Verlängerungsrohre AF**

		Ø	17 mm		
	Stahl	p. St.	Länge 100 cm	13.68	AF 261.004.021

**530-11 Flexibler Verbinder 50 mm<sup>2</sup>, mit Kabelschuhen AF**

	Kartons à 10 Stück				
	50 mm <sup>2</sup> , für M10	p. St.	Länge 330 mm	18.27	AF 285.098.405

**530-12 Überbrückungsband, flexibles Geflecht AF / SPD**

	beidseitig gelocht 4 x 4/5 / 1 x 10,5 mm				
	Kartons à 10 Stück				
	Kupfer blank	p. St.		7.10	
	Kupfer verzinkt			10.95	AF 265.059.000

**551-01 Fangstangen für Wandmontage AF / SPD**

mit Verbindungsklemme und Befestigung

		Länge	1 m	1,5 m	2 m	
	Alu	Ø 10 mm	p. St.	22.50	29.90	35.25
	Cr-Ni-Stahl	Ø 10 mm		49.15	44.90	78.05

**551-11 Fangstangen, freistehend AF**

mit Verbindungsklemme und Sockel

		Länge	1 m	1,5 m	2 m	2,5 m	3 m	
		Sockel	3 kg	10 kg	10 kg	15 kg	15 kg	
	Alu	Ø 16/10 mm	p. St.	29.79	35.59	37.53	54.85	63.49

  

		Länge		3,5 m	4 m
		Sockel		25 kg	30 kg
	Alu	Ø 16/10 mm	p. St.	78.88	87.52

		Länge	3 m	3,5 m	4 m	4,5 m	5 m	
		Sockel	25 kg	35 kg	45 kg	60 kg	80 kg	
	Alu	30/16/10 mm	p. St.	188.55	230.89	301.14	400.23	504.13

**551-21 Fangmasten mit Neigungsausgleich AF**

		Länge	5 m - 8 m
	Alu	p. St.	auf Anfrage

**551-31 Fangstange isoliert abgestützt AF**

		Länge	3,5 m - 5 m
	Alu	p. St.	auf Anfrage

Blitzschutz

10

1

2

3

4

5

6

7

8

9

10

11

12

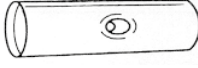

**570-01 Pressverbinder AF**

Kartons à 100 Stück		<b>25 mm<sup>2</sup></b>		<b>35 mm<sup>2</sup></b>	
		Ø 6 mm		Ø 8 mm	
	Kupfer blank	p. St.	1.39	1.75	AF 414.061.530 / 414.061.540 H
	Kupfer verzinkt		1.39	1.75	AF 414.061.531 / 414.061.541 H

**570-11 Presskabelschuh mit Loch, für Anschluss M 8 - M 12 (H) AF**

Kartons à 100 Stück		<b>25 mm<sup>2</sup></b>				<b>35 mm<sup>2</sup></b>		
		Ø 6 mm				Ø 8 mm		
		<b>M 6</b>	<b>M 8</b>	<b>M 10</b>	<b>M 12</b>	<b>M 8</b>	<b>M 10</b>	
	Kupfer blank	p. St.	1.08	1.08	1.08	1.17	1.66	1.75
	Kupfer verzinkt		1.08	1.08	1.08	1.17	1.71	1.80

**570-15 Presskabelschuh (mit 3 Nietlöchern) zum Aufnieten AF**

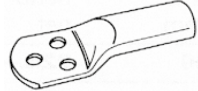
Kartons à 100 Stück		Ø 6 mm		
	Kupfer blank	p. St.	1.53	AF 414.060.062
	Kupfer verzinkt		1.62	AF 414.060.063

**570-17 Anschluss-Set AF**

mit 7 Bechernieten

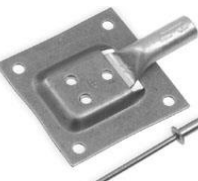
Kartons à 25 Stück		Ø 6 mm		
	Kupfer blank	p. St.	6.25	AF 275.054.000
	Kupfer verzinkt		8.23	AF 270.081.000

2019 / 11

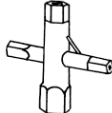

**581-01 Blitzschutz-Universal-Schlüssel AF**

	Kreuzschlüssel	p. St.	für M10, M13, M17 und M19	18.00	AF 246.002.00
---	----------------	--------	---------------------------	-------	---------------

**582-07 Bolzenschneider SPD**

	für max. Ø 6 mm Stahl / Ø 8 mm Kupfer	200 mm
	p. St.	47.30

**582-13 Blitzschutzdraht-Richtapparat SPD**

	Ø 6 - 8 mm
	p. St. 698.00

**570-81 Presszange SPD**

	Ø 6 - 10 mm
	p. St. 159.00



Fordern Sie bei Bedarf den kompletten Arthur Flury Katalog bei uns an.

2019 / 11

# PROFILIEREN, KANTEN, ZUSCHNEIDEN, ORNAMENTE



Fassade



Flachdach



Steildach



Mauer- und Attikaabdeckungen



Scharen



Ornamente

## 451-01 Lüfterfirst

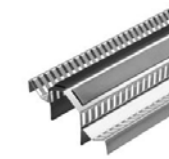

Cr-Ni-Stahl

p. m.

33.00

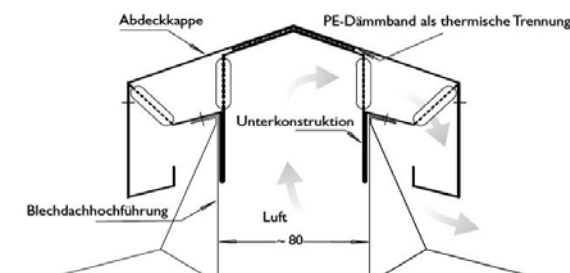
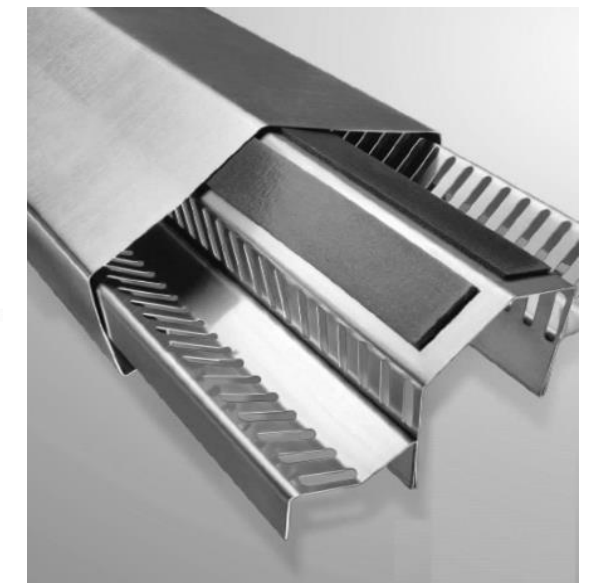

### Lüfterfirst

- Labyrinth-Lüfterkonstruktion für Metaldachdeckung an First und Grat.
- Lüfterkonstruktion aus Metall freitragend, bestehend aus Unterkonstruktionsprofil und Abdeckkappe, einschliesslich PE-Dämmband
- Unterkonstruktion aus Edelstahl 0.5 mm dick, Material der Abdeckkappe nach Kundenangabe in allen handelsüblichen Baumetallen.
- Kurze Montagezeit.
- Kleinste Baumasse (keine Holzunterkonstruktion erforderlich)

2019 / 11

**Ob Flachdach, Steildach oder Fassade, wir fertigen für Sie, was aus Blech gefertigt werden kann:**

- MAUERABDECKUNG
- SCHUTZBLECH
- DECKSTREIFEN
- EINFASSUNGEN
- SEITENBLECH
- KEHLBLECH
- EINLAUFBLECH
- BRUSTBLECH
- ORTBLECH
- DOPPELFALZDACH
- GURTENBLECHE
- FENSTERBANK
- FENSTERZARGEN
- FASSADENPROFILE
- ECKBLECHE
- SCHAREN RUND UND KONISCH MIT FIRST UND TRAUFBABSCHLÜSSEN

Gerne liefern wir Ihre Aufträge in allen Baumetallen direkt auf die Baustelle: «Just in Time». Rufen Sie uns bei Ihrem nächsten Projekt an. Wir erarbeiten Ihnen ein zugeschnittenes Angebot.



**Kurvenkehlen®**



Anfrage  Bestellung



Beispiel: Verlegung einer Kurvenkehle mit rundem Anschluss.



Letzte Gaubenschar dem Kehilverlauf entsprechend anschneiden. Gaubenschar ca. 40 mm rund aufkanten Kurvenkehle® einbauen Gaubenschar anlegen und mit Kurvenkehle® verfalzen.

Fertigung in allen handelsüblichen Baumetallen. Der Kehlfalz ist vor dem Einbau durch den Verleger dicht zu löten. Ausnahme: Kurvenkehle sollte vor dem Eindecken der Dachziegel der kostenlos mitgelieferte Kehldichtstreifen eingebaut werden, um eine optimale Abdichtung gegen Flugschnee und Treibwasser zu erreichen.

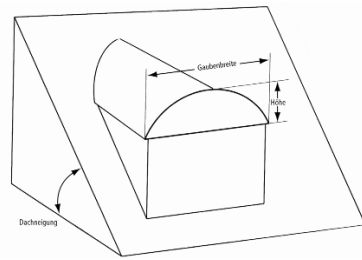

**Kurvenkehlen**

Anzahl und Länge der Kehleanteile ist abhängig von der Gaubengrösse und wird durch uns beim Programmieren festgelegt. Die Abrechnung erfolgt pro Laufmeter Kehllänge am Kehlfalz (Kehlnickbereich) zuzüglich Nahtzugaben. Pro Gaube werden zusätzlich Programmierkosten verrechnet bei massgleichen Gauben fallen die Programmierkosten nur einmalig an).

**Technische Angaben**

Ziegeldeckung  Metalldeckung

Gaubensbreite: ..... Material: .....

Anzahl Gauben: ..... Dachneigung: .....

Höhe: .....

Deckungsart der Hauptdachfläche:

**Rundblenden**

Anfrage  Bestellung

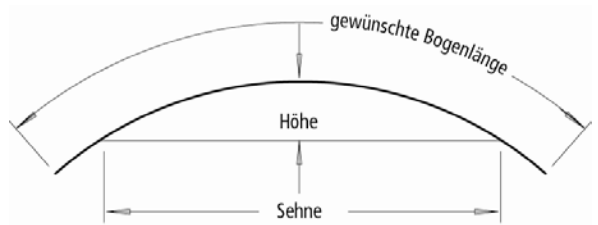

**Rundblenden**

Blenden an der Gaubenvorderseite in verschiedenen Ausführungen. Blenden in jeder Sonderausführung nach Kundenwunsch möglich. Die Einzellängen sind abhängig von Blendenhöhe, Radius und Material. Fertigung in allen handelsüblichen Baumetallen.

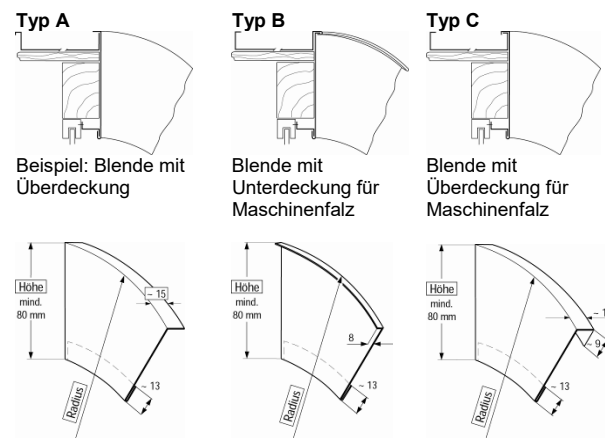

**Technische Angaben**

Typ A  Typ B  Typ C

Menge: ..... Radius: .....

Höhe: ..... oder .....

Material: ..... Sehne:\* .....

Höhe:\* .....

\* aus Sehne und Höhe kann der Radius errechnet werden.

**Rundscharen-Sonderformen und Kuppelscharen**

Anfrage  Bestellung

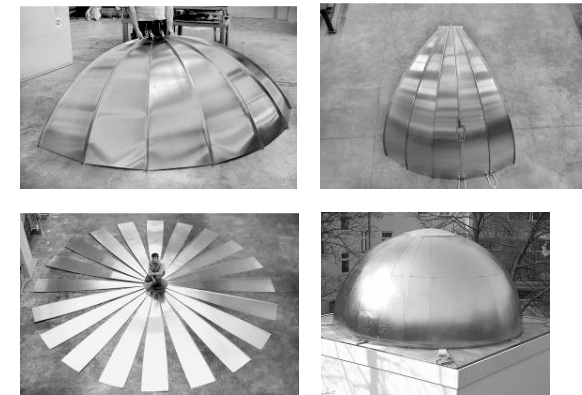

**Beispiele**

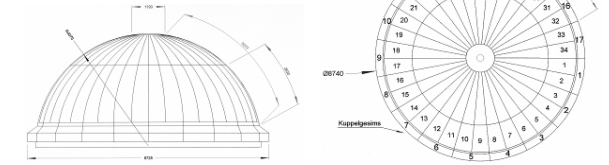

**Rundscharen-Sonderformen**

Wir fertigen Scharen mit Ober- und Unterfalz (Maschinenfalz) für Kuppeln, Türme, Rotunden und andere Bauformen.

- konvex oder konkav gerundet
- konisch konvex oder konkav gerundet
- bogenförmig konvex oder konkav gerundet

Bei Bedarf messen wir vor Ort auf, ermitteln die Abwicklung und erstellen einen Verlegeplan.

**Technische Angaben**

Bitte senden Sie uns eine Skizze mit Massangaben.

**Sonderprofile rund**



Anfrage  Bestellung

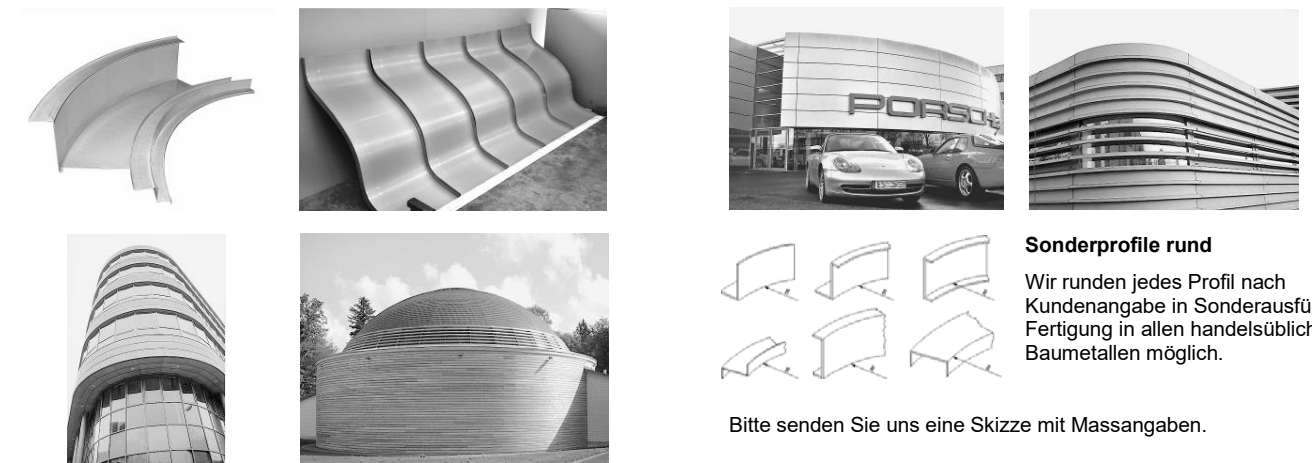

**Sonderprofile rund**

Wir runden jedes Profil nach Kundenangabe in Sonderausführung Fertigung in allen handelsüblichen Baumetallen möglich.

Bitte senden Sie uns eine Skizze mit Massangaben.

**Fassadenpaneele rund**

Anfrage  Bestellung

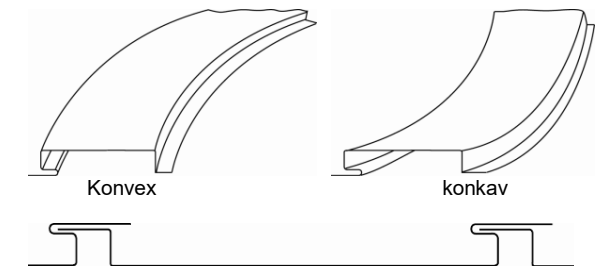
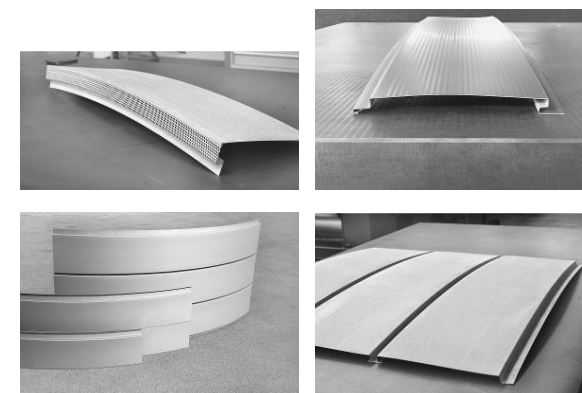

**Fassadenpaneele rund**

Wir runden Fassadenpaneele konvex und konkav in verschiedenen Querschnitten diverser Hersteller (z.B. Steckfalzpaneel, Horizontalpaneel u.a.)



**Kastenrinnen**

Anfrage  Bestellung

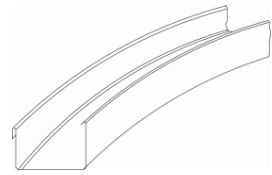

z.B. Kastenrinne horizontal  
Aussernungung mit Umschlag  
Und Wasserfalz



z.B. Kastenrinne vertikal  
gerundet



z.B. Kastenrinne horizontal  
Aussernungung mit Wulst  
und Einklebeschnekel mit  
oder ohne Neigung



z.B. Kastenrinne  
horizontal Ausser-  
nungung mit Wulst  
und Wasserfalz nach DIN

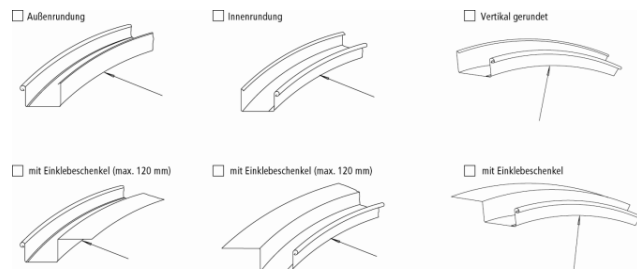
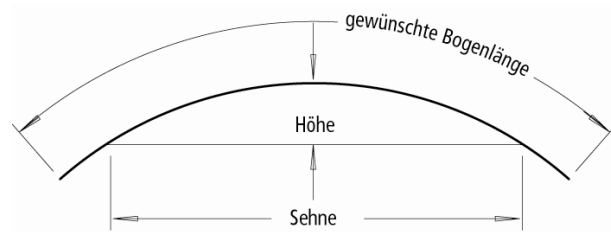

- Grösse 25/8  Grösse 28/7  Grösse 33/6  
 Grösse 40/5  nach eigenen Angaben  
 Wulst  Umschlag  
 Neigung (Skizzenblatt wird Ihnen zugesandt)

Radius: .....  
 Sehne: .....  
 Höhe: .....  
 Höhe 2: .....  
 Neigung: .....  
 Material: .....



**Mauer- und Attikaabdeckungen horizontal rund**

Anfrage  Bestellung

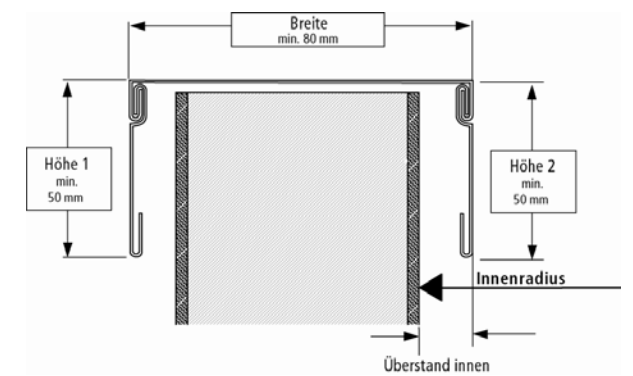
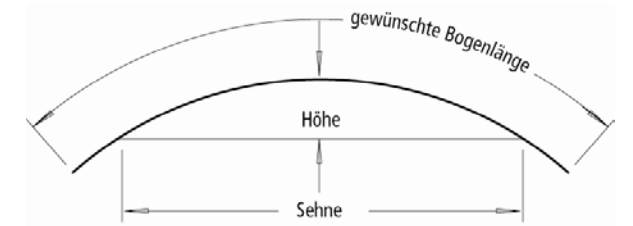
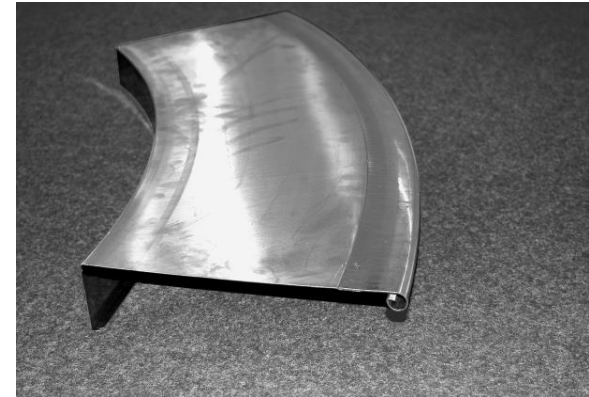
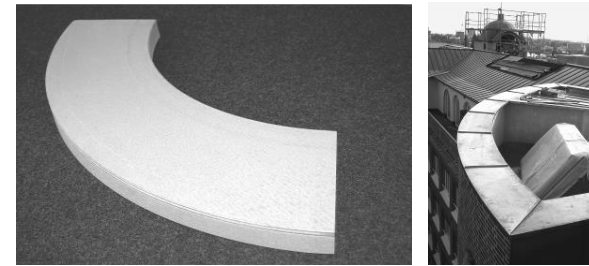

Äussere Bogen-  
 Länge der Mauer: .....  
 Höhe 1: .....  
 Breite: .....  
 Höhe 2: .....  
 Überstand innen: .....  
 Neigung: .....  
 Material: .....

Innenradius Mauer:  
 .....  
 oder .....  
 Sehne\*: .....  
 Höhe\*: .....

\* aus Sehne und Höhe kann der Radius errechnet werden.

**Verlegebeispiele**

- mit Stossblechen stumpf gestossen
- durch Rückkanten der Enden und Aufschieben einer Kappe (z.B. System Rheinzink – siehe Foto und Skizze)

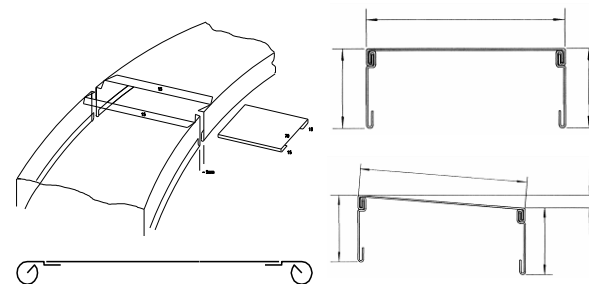

**Mauer- und Attikaabdeckungen horizontal gerundet**  
 Fertigung in beliebiger Breite und variablen seitlichen Abkantungen möglich. Die seitlichen Abkantungen sind bogenförmig eingefalzt und durchgesetzt. Einzellängen bis 2000 mm, abhängig von Zuschnitt und Radius. Fertigung in allen handelsüblichen Baumaterialien.

**Sonderausführungen**

- mit Neigung
- mit Wulst
- einteilig (ab 2.0 mm Materialdicke)



1  
2  
3  
4  
5  
6  
7  
8  
9  
10  
11  
12

Blechfertigung / Scharen / Profile / Ornamente



# Fassaden Systeme

## Alu-Platten 3 mm farbbeschichtet

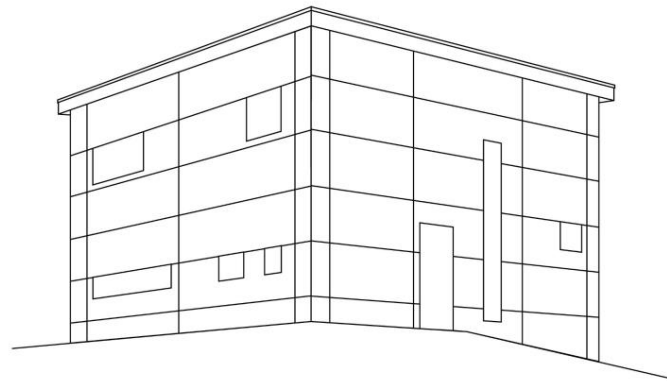

*Linac*

**Material**  
Aluminium 3,0 mm  
pulverbeschichtet  
silbergrau

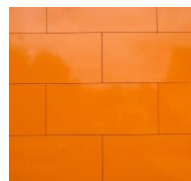

*Kindergarten*

**Material**  
Aluminium 3,0 mm  
pulverbeschichtet  
RAL 2000



# Fassaden Systeme

## Schindeln und Rauten

### Verschiedene Deckmöglichkeiten Schindeln

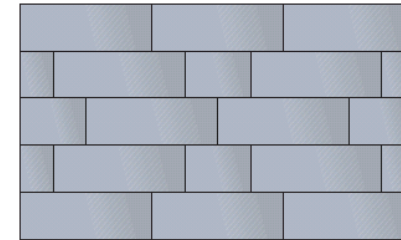

Deckung A: Unterschiedliche Breiten symmetrisch

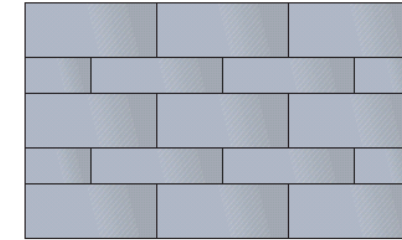

Deckung B: Unterschiedliche Höhen versetzt

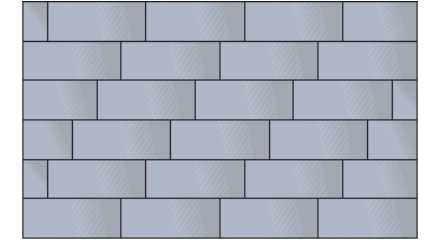

Deckung C: horizontal 5/4 versetzt

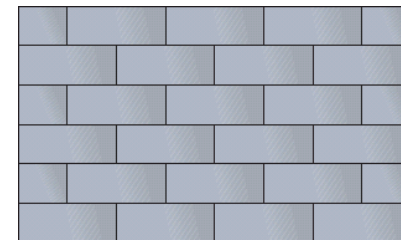

Deckung D: horizontal 1/2 versetzt

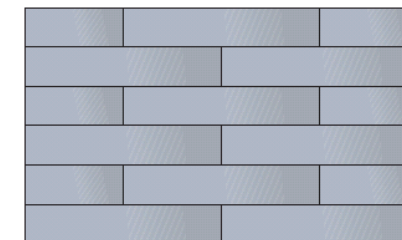

Deckung E: horizontal 1/2 versetzt lang

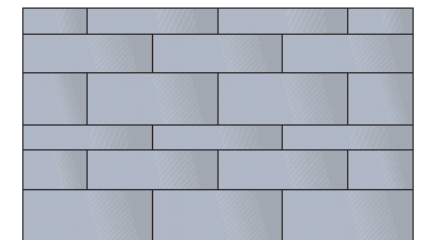

Deckung F: Untersch. Höhen und Breiten versetzt

### Verschiedene Deckmöglichkeiten Rauten

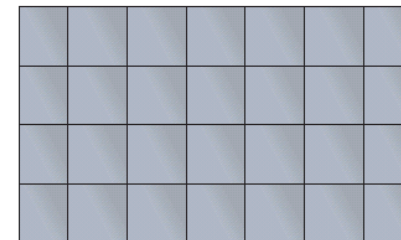

Deckung K: Raute quadratisch

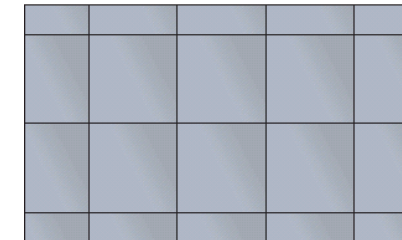

Deckung L: Raute quadratisch gross

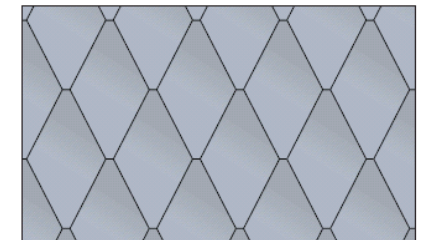

Deckung P: Spitzraute vertikal

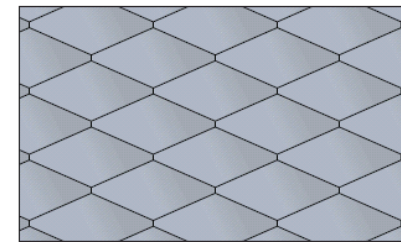

Deckung O: Spitzraute horizontal

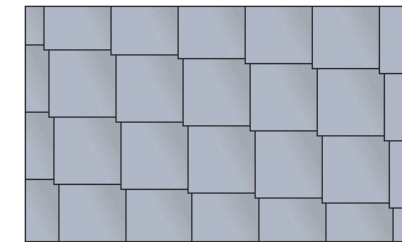

Deckung M: Raute quadratisch versetzt

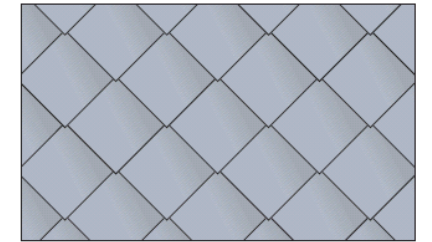

Deckung N: Raute quadratisch auf Kopf



# Fassaden Systeme

## Schindeln und Rauten

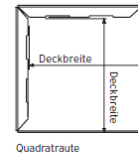
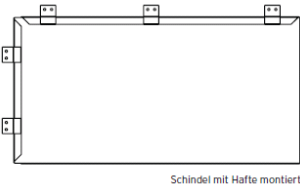
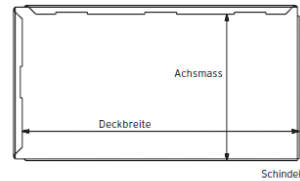

Quadratrate

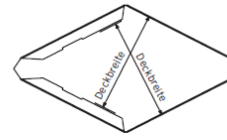

Spitzraute

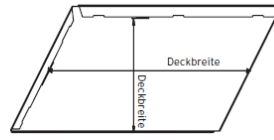

Rhombusraute

Material Hafte:  
CrNi 0,5 mm blank

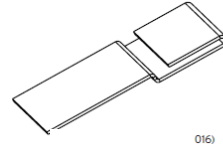

.016)

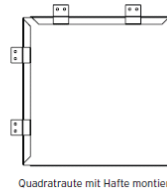

Quadratrate mit Hafte montiert

### Masse Schindeln (Standardmasse)

Deckungsform	Deckmass	Stück/m <sup>2</sup>
Horizontal	467 x 237 mm	ca. 9,0 Stk.
Horizontal	917 x 250 mm	ca. 4,4 Stk.
Horizontal	916 x 416 mm	ca. 2,6 Stk.
Vertikal	237 x 467 mm	ca. 9,0 Stk.
Vertikal	250 x 917 mm	ca. 4,4 Stk.
Vertikal	416 x 916 mm	ca. 2,6 Stk.
Diagonal	917 x 250 mm	ca. 4,4 Stk.

### Masse Rauten (Standardmasse)

Schindelart	Deckmass	Stück/m <sup>2</sup>
Spitz	211 x 211 mm	ca. 22,5 Stk.
Spitz	247 x 247 mm	ca. 16,4 Stk.
Quadrat	160 x 160 mm	ca. 39,1 Stk.
Quadrat	240 x 240 mm	ca. 17,4 Stk.
Quadrat	308 x 308 mm	ca. 10,5 Stk.
Quadrat	408 x 408 mm	ca. 6,0 Stk.
Rhombus	249 x 763 mm	ca. 5,3 Stk.

Weitere Masse und Formate auf Anfrage möglich.

## Fabrikneubau MEVO

**Material**  
Kupfer 0,7 mm  
Architekturrauten

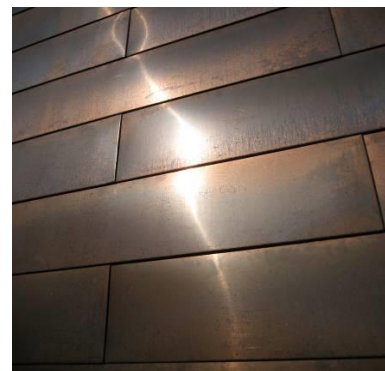

### 824-50 Zier-Stern 8-zackig, 100 mm



Kupfer	p. St.	*
Zink		*

### 824-51 Zier-Blume 6-blättrig, 95 mm



Kupfer	p. St.	*
Zink		*

### 806-01 Ausspeier Drachenkopf gepresst



	Ø	30 mm	42 mm	65 mm	80 mm
Kupfer	p. St.	*	*	*	*
Zink		*	*	*	*

### 806-11 Ausspeier Drachenkopf handgefertigt



	Ø	50 mm	60 mm	75 mm	100 mm
Kupfer	p. St.	*	*	*	*
Zink		*	*	*	*

\* Preise auf Anfrage



2019 / 11



**851-01 Turmkugel mit Wulst in 2 Halbkugeln**

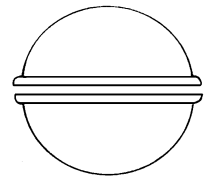

	Ø	30 mm	40 mm	50 mm	60 mm	70 mm
Kupfer	p. St.	*	*	*	*	*
Zink		*	*	*	*	*

	Ø	80 mm	100 mm	120 mm	150 mm	180 mm
Kupfer	p. St.	*	*	*	*	*
Zink		*	*	*	*	*

  

	Ø	200 mm	220 mm	250 mm	280 mm	300 mm
Kupfer	p. St.	*	*	*	*	*
Zink		*	*	*	*	*

	Ø	350 mm	400 mm	500 mm	550 mm	600 mm
Kupfer	p. St.	*	*	*	*	*
Zink		*	*	*	*	*

**851-02 Turmkugel OHNE Wulst in 2 Halbkugeln**

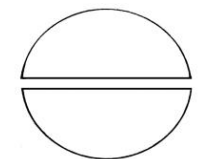

						*
--	--	--	--	--	--	---

\* Preise auf Anfrage

rufen Sie uns an für weitere Kugeln in anderen Dimensionen, flach- oder hochoval, vergoldet...

**Ornamente**

nach alten Vorlagen in bester Handwerkskunst  
originalgetreu rekonstruiert



Ausspeier, Zierornamente, Jalousiebleche, Schindeln, Rinnenkasten,  
Kichturmkugeln, Wetterhähne, Firstbekrönung, Wetterfahnen, Turmspitzen,  
Ornamentfenster, Zierwulsten.... usw. **Rufen Sie uns an!**



# GERNE SIND WIR IHR PARTNER FÜR WERKZEUGE & MASCHINEN



## 10015259 Silikonkitt Falcone Multiplo Allround



oximvernetzend

transparent

Kartuschen à 310 ml

p. St.

6.90

## 902-31 Gyso Polyflex 444 Montagekleber



zum Verkleben und Abdichten

Kartuschen à 290 ml

p. St.

grau

13.90

## 901-48 Handpress-Pistole



für Kartuschen à 310 ml

p. St.

31.32

## 901-51 Fugenband für Falzdächer



Rolle à 18.40 m

10 x 1 mm

anthrazit

p. m

0.75

2019 / 11



**901-52 SPENGLER Falzgel 80 Dachneigung > 10 Grad**

Verhindert das Eindringen von Feuchtigkeit bei Falzdächern, für alle Materialien geeignet.  
1 lt ergibt ca. 100 m Falzabdichtung



		1 lt	5 lt
Flasche	p. St.	28.62	117.72



1. Auftragen



2. Scharen vorbereiten

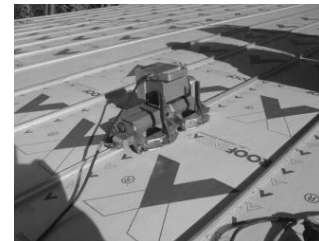

3. Falzen

**901-52 Aufsteckpinsel für 1 lt Flasche Falzgel**



Pinsel	p. St.	10.69
--------	--------	-------

**901-53 Runotex TIX Falzdichtmasse**

Dachneigung > 1 Grad, für alle Materialien geeignet  
1 Kartusche ca 25 m<sup>1</sup>



		300 ml
Flasche	p. St.	11.88

**901-57 Falzversiegelung BLUE WATER**

speziell für das nachträgliche Versiegeln von Uginox Falzen  
1 lt ergibt ca. 200 m Falzversiegelung



		à 5 lt
Eimer	p. St.	232.20

2019 / 11



**902-02 Breitkopfstifte**



		Dim. mm	2,5 x 20	2,5 x 25	2,5 x 27	2,5 x 30
verzinkt	p. Pk.	Pakete à 2,5 kg	-	39.00	-	39.00
Kupfer		Pakete à 1,0 kg	24.50	24.50	24.50	24.50
		Dim. mm		2,5 x 25	2,5 x 27	2,7 x 30
Cr-Ni-Stahl		Pakete à 1,0 kg		19.50	19.50	19.50

**902-03 Flachkopfstifte**



		Dim. mm	4,0 x 90	4,0 x 100
blank	p. Pk.	Pakete à 5,0 kg	19.50	19.50
verzinkt		Pakete à 5,0 kg	29.50	29.50

Weitere Dimensionen auf Anfrage

**865-18 Haftennägel für Haubold Coil-Nagler RNC 50 S**

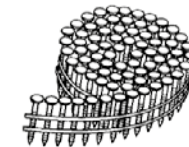

		Dim. mm	2,5 x 25	2,8 x 35
		St./Paket	3'600	2'400
Cr-Ni-Stahl	p. Pk.		128.30	95.05

**865-59 Set Streifennägel und Treibstoffzellen Paslode gelb**



Set 2000 Nägel und 2 Treibstoffzellen

		Dim. mm	2.80 x 25	2,8 x 32
EDELSTAHL	p. Set		123.12	186.84

**865-60 Treibstoffzellen Paslode gelb**



	p. Pk.	Pakete à 2 St.	26.46
--	--------	----------------	-------

2019 / 11





**902-08 Betonnägel H2**

Pakete à 200 Stück	mm	6,1 x 35	6,1 x 40	6,1 x 50	6,1 x 60	6,1 x 80	
		p. Pk.	49.00	51.00	56.00	61.00	69.00
verzinkt							
Pakete à 100 Stück	mm	6,1 x 100	6,1 x 120	6,1 x 140	6,1 x 160	6,1 x 180	6,1 x 200
verzinkt	p. Pk.	47.00	54.00	75.00	91.00	94.00	106.00

**902-10 Draht**

zum Befestigen von Speiern etc.

verzinkt	p.St.	1.5 mm Rolle à 15.5 m	4.50
Kupfer	p.St.	1.0 mm Rolle à 7.0 m	4.00
Cr-Ni-Stahl	p.St.	1.0 mm Rolle à 8.0 m	5.50

**902-11 Nageldübel mit Kreuzschlitz**

	Ø x Länge mm	5 x 30	5 x 40	6 x 35	6 x 40	6 x 60
		Bohrloch	40 mm	50 mm	45 mm	50 mm
	Nutzlänge	5 mm	20 mm	10 mm	15 mm	35 mm
	Pakete à	200 St.	200 St.	200 St.	200 St.	200 St.
verzinkt gelb	p. Pk.	6.50	7.20	8.80	9.20	12.00
Cr-Ni-Stahl		24.00	27.50	31.00	35.00	44.00
	Ø x Länge mm	6 x 80	8 x 80	8 x 100	8 x 120	8 x 140
	Bohrloch	90 mm	90 mm	110 mm	130 mm	150 mm
	Nutzlänge	50 mm	50 mm	60 mm	80 mm	100 mm
	Pakete à	200 St.	100 St.	100 St.	100 St.	100 St.
verzinkt gelb	p. Pk.	14.50	10.00	13.50	26.00	34.00
Cr-Ni-Stahl		64.00	49.00	62.00	-	-

2019 / 11



**902-27 Spengler-Schrauben, inkl. Dichtung + Rosette**

Torx 20	Dim. Pakete à	mm	4,5 x 19	4,5 x 25	4,5 x 35
			200 St./p. Vollgewinde	200 St./p.	200 St./p.
Cr-Ni-Stahl blank	p. Pk.		15.00	11.00	12.00
Cr-Ni-Stahl verkupfert			16.00	12.00	13.00
	Dim. Pakete à	mm	4,5 x 45	4,5 x 60	4,5 x 80
			200 St./p.	200 St./p.	200 St./p.
Cr-Ni-Stahl blank	p. Pk.		15.00	16.00	22.00
Cr-Ni-Stahl verkupfert			16.50	18.00	25.00
	Dim. Pakete à	mm	4,5 x 100	4,5 x 120	4,5 x 150
			100 St./p.	100 St./p.	100 St./p.
Cr-Ni-Stahl blank	p. Pk.		13.00	19.00	26.00
Cr-Ni-Stahl verkupfert			15.50	23.00	31.00
Torx 25	Dim. Pakete à	mm	5 x 180	5 x 200	5 x 220
			50 St./p.	50 St./p.	50 St./p.
Cr-Ni-Stahl blank	p. Pk.		55.00	65.00	-
Cr-Ni-Stahl verkupfert			60.00	74.00	76.00*
	Dim. Pakete à	mm	5 x 240	5 x 260	5 x 300
			50 St./p.	50 St./p.	50 St./p.
Cr-Ni-Stahl blank	p. Pk.		65.00	84.00*	91.00
Cr-Ni-Stahl verkupfert			78.00	97.00*	104.00

2019 / 11





**902-28 Spengler-Schrauben Torx - mit aufgestecktem Dübel**

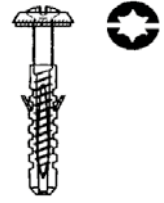

	Dim. Pakete	mm	4,5 x 35 200 St.
Cr-Ni-Stahl blank	p. Pk.		30.00
Cr-Ni-Stahl verkupfert			35.00

**902-30 DELTA Spiraldübel**



		Gr. 5 3 - 4 mm	Gr. 6 3,5 - 5 mm	Gr. 8 4,5 - 6 mm
für Schrauben von		100	100	100
Anzahl St./Paket		10	10	8
Verpackungsein.				
Nylon	p. Pk.	2.70	3.90	5.50

		Gr. 10 6 - 8 mm	Gr. 12 8 - 10 mm	Gr. 15 10 - 12 mm
für Schrauben von		50	25	20
Anzahl St./Paket		8	8	8
Verpackungsein.				
Nylon	p. Pk.	5.90	4.40	7.20

**902-40 Isolations-Dübel**



		Gesamtlänge max. Schraubenlänge für Schraube Ø Pakete à	50 40 4-5 mm 100 St.	95 75 8 mm 25 St.
Nylon	p. Pk.		46.00	29.00

2019 / 11



**902-37 Isolierdübel mit Schraube / Dichtung / Rosette**



Verpackungsein.	5 Pakete	Rosette Ø Länge	15 mm 45 mm	20 mm 45 mm
Kupfer	p. Pk.	Pakete à 100 St.	71.00	74.00
Cr-Ni-Stahl			71.00	74.00

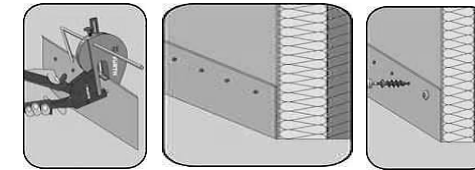

- Löcher stanzen  
Ø 10 mm
- Blech anlegen
- Isolierdübel

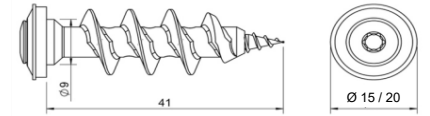

**902-38 STYROFIX Isolations-Dübel M10**



20 - 60 mm mit Abdeckrossette und Schutzhülle  
Verpackungsein. 2 Sets

verzinkt	Kartons à 5 Set à 5 Stück (25 Stück)	p.k	99.50
Cr-Ni-Stahl		p.k	112.00

**902-39 Verlängerung M10**



Verpackungsein.	5 Sets	Länge	35 mm
Cr-Ni-Stahl	p. Set	Set à 5 St.	16.50

2019 / 11



**902-73 Bechernieten**

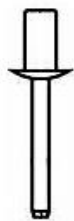

Klemmlänge mm	0,5 - 1,5	1,5 - 3,0	3,0 - 5,0	5,0 - 7,0	0,5 - 1,5	1,5 - 3,0
Länge mm	<b>3,2 x 6,0</b>	<b>3,2 x 8,0</b>	<b>3,2 x 9,5</b>	<b>3,2 x 12,0</b>	<b>4,0 x 6,0</b>	<b>4,0 x 8,0</b>
Pakete à	1000 St./p.	1000 St./p.	1000 St./p.	1000 St./p.	500 St./p.	500 St./p.
<b>Cr-Ni-Stahl mit Edelstahlstift</b>	p. Pk. 114.00	123.00	136.00	158.00	79.00	83.00
Klemmlänge mm	3,0 - 5,0	5,0 - 6,5	3,0 - 5,0	5,0 - 6,5	6,5 - 10,5	10,5 - 14,0
Länge mm	<b>4,0 x 9,5</b>	<b>4,0 x 12,0</b>	<b>4,8 x 9,5</b>	<b>4,8 x 12,0</b>	<b>4,8 x 16,0</b>	<b>4,8 x 20,0</b>
Pakete à	500 St./p.	500 St./p.	250 St./p.	250 St./p.	250 St./p.	250 St./p.
<b>Cr-Ni-Stahl mit Edelstahlstift</b>	p. Pk. 88.50	98.00*	51.00	61.00	65.50	71.00
Klemmlänge mm	0,5 - 2,0	2,0 - 3,0	3,5 - 5,0	5,0 - 8,0	0,5 - 3,5	3,5 - 5,0
Länge mm	<b>3,2 x 6,5</b>	<b>3,2 x 8,0</b>	<b>3,2 x 9,5</b>	<b>3,2 x 12,5</b>	<b>4,0 x 8,0</b>	<b>4,0 x 10,0</b>
Pakete à	1000 St./p.	1000 St./p.	1000 St./p.	1000 St./p.	500 St./p.	500 St./p.
<b>Kupfer mit Edelstahlstift</b>	p. Pk. 70.50	73.50	80.00	90.50	55.50	58.50*

\* für Blitzschutz Blech-Anschlüsse

**902-75 Blindnieten**



	<b>CB 1</b>	<b>CB 2</b>	<b>CB 3</b>	<b>CB 4</b>	<b>CB 5</b>	<b>CB 6</b>
Klemmlänge mm	0,5 - 2,0	2,0 - 3,0	3,0 - 4,0	5,0 - 6,0	7,0 - 9,0	9,0 - 12,0
Länge mm	<b>3,2 x 5,0</b>	<b>3,2 x 6,0</b>	<b>3,2 x 7,0</b>	<b>3,2 x 9,0</b>	<b>3,2 x 12,0</b>	<b>3,2 x 15,0</b>
Pakete à	1000 St./p.	1000 St./p.	1000 St./p.	1000 St./p.	500 St./p.	500 St./p.
<b>Kupfer mit Broncestift</b>	p. Pk. 41.50	43.00	44.50	48.50	29.00	34.50
	<b>AL 2</b>	<b>AL 3</b>	<b>AL 4</b>	<b>AL 5</b>	<b>AL 6</b>	
Klemmlänge mm	2,0 - 3,0	3,0 - 4,0	5,0 - 6,0	7,0 - 9,0	9,0 - 12,0	
Länge mm	<b>3,2 x 6,0</b>	<b>3,2 x 7,0</b>	<b>3,2 x 9,0</b>	<b>3,2 x 12,0</b>	<b>3,2 x 15,0</b>	
Pakete à	1000 St./p.	1000 St./p.	1000 St./p.	1000 St./p.	1000 St./p.	
<b>Alu mit Eisenstift</b>	p. Pk. 17.00	18.00	22.00	26.00	30.00	
	<b>CRNI 1</b>	<b>CRNI 2</b>	<b>CRNI 3</b>	<b>CRNI 4</b>	<b>CRNI 5</b>	<b>CRNI 6</b>
Klemmlänge mm	0,5 - 2,0	2,0 - 3,0	3,0 - 4,0	5,0 - 6,0	7,0 - 9,0	9,0 - 12,0
Länge mm	<b>3,2 x 5,0</b>	<b>3,2 x 6,0</b>	<b>3,2 x 7,0</b>	<b>3,2 x 9,0</b>	<b>3,2 x 12,0</b>	<b>3,2 x 15,0</b>
Pakete à	1000 St./p.	1000 St./p.	1000 St./p.	1000 St./p.	500 St./p.	500 St./p.
<b>Cr-Ni-Stahl mit Edelstahlstift</b>	p. Pk. 42.00	43.50	45.50	49.50	31.50	38.00



**902-76 Handnietzange Gesipa Flipper**



mit Auffangbehälter für Stifte

für Ø 2,4 / 3,2 / 4,0 / 4,8 mm

Handnietzange	p. St.	76.89
---------------	--------	-------

**902-76 Handnietzange Gesipa NTX-F**



bis 5 mm Alu / 4 mm Edelstahl

Handnietzange	p. St.	64.47
---------------	--------	-------

**902-76 Handnietzange Gesipa NTS**



bis 5 mm Alu / 4 mm Edelstahl

Handnietzange	p. St.	42.12
---------------	--------	-------

**902-79 Handnietzange POP TT 55 / Ersatzteile**



für Ø 2,4 / 2,8 / 3,2 / 4,0 mm  
inox I MEX nur bis 3,2 mm

Handnietzange	p. St.	39.50
---------------	--------	-------

Splint / Bolzen		19.00
-----------------	--	-------

Backen (Paar)		21.50
---------------	--	-------

**902-77 Blindnietler Gesipa Accu Bird**

inkl. 1 Akku und Ladegerät, mit Stahlkoffer

für Ø 3,2 / 4,0 / 4,8 mm

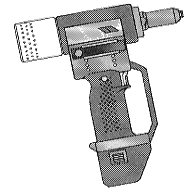

Nietgerät	p. St.	798.12
Ersatzakku		160.92

\* auf Anfrage

**902-80 Handnietzange POP PS 15**

für Ø 2,4 / 3,2 / 4,0 / 4,8 mm (Alu)

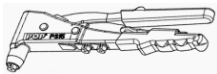

	p. St.	71.00
--	--------	-------

**902-81 Nieten-Bohrer HSS**



		einseitig	zweiseitig
Ø 3,3 mm	p. Beutel à 10 Stück	40 mm 6.50	50 mm 8.90
Ø 4,1 mm	p. Beutel à 10 Stück	-	17.00

2019 / 11

**REES**

Das komplette Haftprogramm für Stehfalz / Snapfalz



Ausführung nach den entsprechenden Vorgaben der Fachregeln des Spengler-Handwerks in Materialstärke und Abmessung, verbunden mit den neusten Anforderungen aus der täglichen Praxis.

- **Festhafte** mit abgerundeten Ecken und leichter Abkantung am Fussende. Auf Wunsch auch mit 25 mm Fussteil.
- **Schiebhaften** mit abgerundeten Ecken und Sicken, um einer Beschädigung der Dacheindeckung entgegenzuwirken.
- **Langschiebhaften**, 70 mm Schiebeteil, für besonders lange Dachbahnen oder Material mit hoher Ausdehnung.

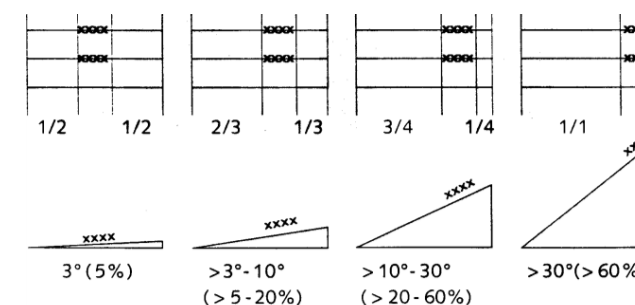

Abstand Hafte zu Hafte min. 100 mm, max. 500 mm  
(4 – 6 Haften pro m<sup>2</sup>)  
Scharenbreite, Windlasten und Gebäudehöhe sind zu berücksichtigen.  
Verteilung Schiebhaften / Festhaften (xxxx = 1 - 3 m)



**902-85 Hosenhafte**

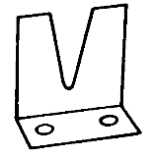

Kartons à 500 Stück		Ab St.	500	1000	2500	5000
Kupfer	p. St.	0.45	*	*	*	*
Cr-Ni-Stahl		0.25	*	*	*	*

**902-86 Hosen-Schiebehafte**

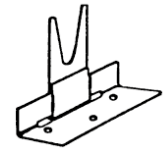

Kartons à 500 Stück		Ab St.	500	1000	2500	5000
Kupfer	p. St.	0.95	*	*	*	*
Cr-Ni-Stahl		0.50	*	*	*	*

**902-87 Liegehaften flach, 50 x 30 mm**

für Umschlag bis 10 mm



Karton à 250 Stück		Ab St.	500	1000	2500	5000
Cr-Ni-Stahl	p. St.	0.22	*	*	*	*

**902-88 Liegehafte**

für Umschlag bis 10 mm, bis 3.5 mm Dicke



Kartons à 250 St.		Ab St.	250	1000	2500	4500
Cr-Ni-Stahl	p. St.	0.22	*	*	*	*

für Umschlag bis 30 mm

Kartons à 250 St.		Ab St.	250	1000	2500	4500
Cr-Ni-Stahl	p. St.	0.22	*	*	*	*

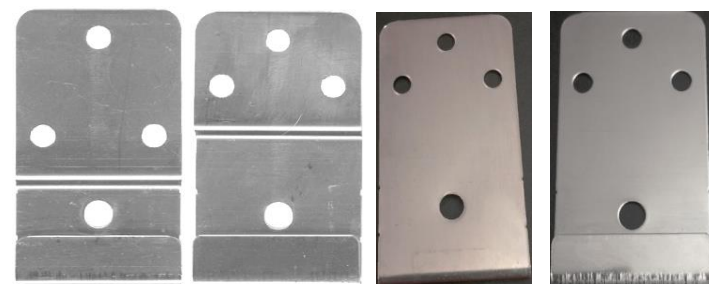

\* grössere Mengen auf Anfrage



**902-91/92 Festhafte für profilierte Scharen**

gemäss Richtlinien Suissetec 2015 (400 N)

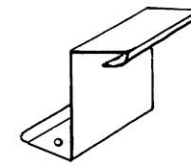

		Ab St.	500	1000	2500	5000
<b>Höhe 25 mm Standard</b>						
Kupfer	p. Pk. à 500 St.	0.26	*	*	*	*
Cr-Ni-Stahl		0.07	*	*	*	*

**Höhe 30 mm (für Strukturmatte)**

Cr-Ni-Stahl	p. Pk. à 500 St.	0.09	*	*	*	*
-------------	------------------	------	---	---	---	---

**Höhe 32 mm**

Cr-Ni-Stahl	p. Pk. à 500 St.	0.11	*	*	*	*
-------------	------------------	------	---	---	---	---

**Höhe 38 mm**

Cr-Ni-Stahl	p. Pk. à 500 St.	0.18	*	*	*	*
-------------	------------------	------	---	---	---	---

**Im Kunststoff-Eimer**



**Höhe 25 mm Standard**

		1 Eimer	2 Eimer	5 Eimer
Cr-Ni-Stahl	p. Eimer à 1000 St.	75.00	*	*
		(-.125/St.)	(-.085/St.)	(-.075/St.)

**Höhe 30 mm (für Strukturmatte)**

Cr-Ni-Stahl	p. Eimer à 1000 St.	95.00	*	*
		(-.155/St.)	(-.095/St.)	(-.085/St.)

**Höhe 32 mm**

Cr-Ni-Stahl	p. Eimer à 1000 St.	116.00	*	*
		(-.135/St.)	(-.115/St.)	(-.105/St.)

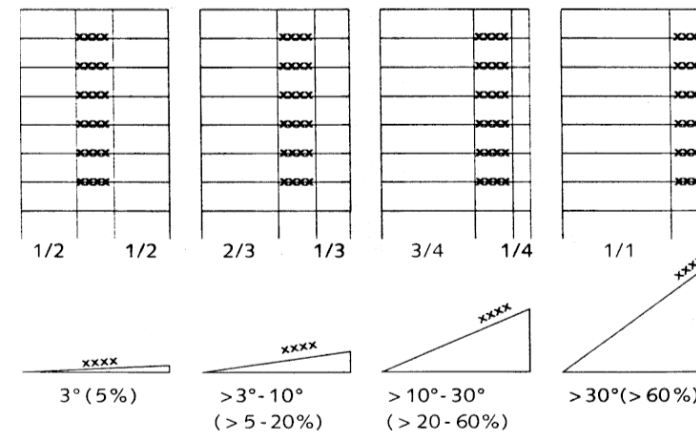

Abstand Hafte zu Hafte min. 100 mm, max. 500 mm

(4 - 6 Haften pro m<sup>2</sup>)

Scharenbreite, Windlasten und Gebäudehöhe sind zu berücksichtigen

Verteilung Schiebehafte / Festhafte ( xxxx = 1-3 m)





**902-93 Schiebehafte für profilierte Scharen**

gemäss Richtlinien Suissetec 2015 (400 N)

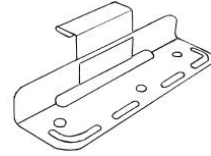

<b>Dilatation 55 mm / Höhe 25 mm</b>		Ab St.	500	1000	2500	5000
Kupfer	p. Pk. à 500 St.	0.75	*	*	*	*
Cr-Ni-Stahl		0.23	*	*	*	*
<b>Höhe 30 mm (für Strukturmatte)</b>		Ab St.	500	1000	2500	5000
Cr-Ni-Stahl	p. Pk. à 500 St.	0.20	*	*	*	*
<b>Höhe 32 mm</b>		Ab St.	500	1000	2500	5000
Cr-Ni-Stahl	p. Pk. à 500 St.	0.25	*	*	*	*
<b>Höhe 38 mm</b>		Ab St.	500	1000	2500	5000
Cr-Ni-Stahl	p. Pk. à 500 St.	0.31	*	*	*	*
<b>Dilatation 70 mm / Höhe 25 mm</b>		Ab St.	400	800	2000	4000
Cr-Ni-Stahl	p. Pk. à 400 St.	0.79	*	*	*	*
<b>Höhe 30 mm</b>		Ab St.	400	800	2000	4000
Cr-Ni-Stahl	p. Pk. à 400 St.	0.69	*	*	*	*
<b>Höhe 32 mm</b>		Ab St.	400	800	2000	4000
Cr-Ni-Stahl	p. Pk. à 400 St.	0.69	*	*	*	*
<b>Höhe 38 mm</b>		Ab St.	400	800	2000	4000
Cr-Ni-Stahl	p. Pk. à 400 St.	0.98	*	*	*	*

**902-93 Im Kunststoff-Eimer**



<b>Dilatation 55 mm / Höhe 25 mm</b>		1 Eimer	2 Eimer	5 Eimer
Cr-Ni-Stahl	p. Eimer à 500 St.	95.00 (0.19/St.)	*	*
<b>Höhe 30 mm (für Strukturmatte)</b>		1 Eimer	2 Eimer	5 Eimer
Cr-Ni-Stahl	p. Eimer à 500 St.	105.00 (0.21/St.)	*	*
<b>Höhe 32 mm</b>		1 Eimer	2 Eimer	5 Eimer
Cr-Ni-Stahl	p. Eimer à 500 St.	130.00 (0.26/St.)	*	*



**902-97 CLIPFIX Festhafte**

gemäss Richtlinien Suissetec 2015

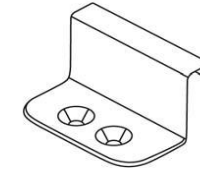

<b>Höhe 25 mm Standard</b>		Ab St.	300	1200	2400	4200
Cr-Ni-Stahl	p. Pk. à 300 St.	0.215	*	*	*	*
<b>Höhe 30 mm (für Strukturmatte)</b>		Ab St.	300	1200	2400	4200
Cr-Ni-Stahl	p. Pk. à 300 St.	0.23	*	*	*	*

**902-98 CLIPFIX Schiebehafte**

gemäss Richtlinien Suissetec 2015

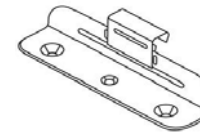

<b>Höhe 25 mm Standard</b>		Ab St.	150	1200	2400	4200
Cr-Ni-Stahl	p. Pk. à 150 St.	0.537	*	*	*	*
<b>Höhe 30 mm (für Strukturmatte)</b>		Ab St.	150	1200	2400	4200
Cr-Ni-Stahl	p. Pk. à 150 St.	0.56	*	*	*	*

\* Preise auf Anfrage

2019 / 11



**903-01 Walzblei**

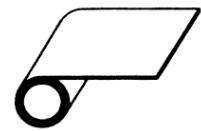

mm	0.75 x 120	0.75 x 420	0.75 x 450
Gewicht / Rolle ca.	10 kg	30 kg	30 kg
Meter / Rolle ca.	9.4 m	8.4 m	7.8 m
Walzblei p. kg	*	*	*

  

mm	1.0 x 120	1.0 x 150	1.0 x 420	1.0 x 1200
Gewicht / Rolle ca.	10 kg	10 kg	30 kg	100 kg
Meter / Rolle ca.	7.4 m	5.9 m	6.3 m	7.2 m
Walzblei p. kg	*	*	*	*

**Walzblei rot/braun**

mm	0.75 x 420	1.0 x 450
Gewicht / Rolle ca.	30 kg	30 kg
Meter / Rolle ca.	8.4 m	5.9 m
Walzblei rot/braun p. kg	*	*

**903-05 Well-Blei**

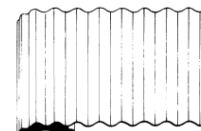

mm	0.75 x 120	0.75 x 150	0.75 x 420
Well-Blei p. kg	*	*	*

**Well-Blei rot/braun**

mm	0.75 x 150	0.75 x 420
Well-Blei rot/braun p. kg	*	*

\* auf Anfrage

2019 / 11



**903-10 Lötzinn in 3-Kant-Stangen**

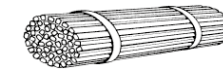

Bunde à 25 kg	210 g / St.
Legierung 40 / 60 p. kg	*
Legierung 50 / 50	*
Legierung 99,9	*

\* auf Anfrage

**903-15 Lötzinndraht**

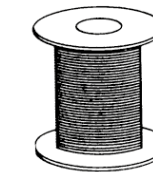

Spulen à	500 g	1000 g
Legierung 40 / 60 p. St. Ø 2 mm	-	35.00
Legierung 50 / 50 Ø 2 mm	19.50	-

2019 / 11



**903-17 Verzinngspaste SOLDERIN S**

für Kupfer- und Stahlbleche



Dosen à	250 g	500 g	1000 g	3000 g
p. St.	16.00	27.00	48.00	140.00

**903-18 Verzinngspaste Reinzinn 99,9%**

für lebensmittelechte Verzinnungen



Dosen à	500 g	1000 g
p. St.	49.00	79.00

**903-19 BERIN-Lötpaste**

für Kupfer und weitere Metalle (ausgenommen Cr-Ni-Stahl und Aluman)



Dosen à	50 g	250 g	450 g	750 g
p. St.	4.50	12.00	17.00	29.00

**903-52 BEROGEN-Punktschweisspaste- zum Kupfer-Punkten**



Dose à	50 g
p. St.	64.50

2019 / 11



**903-20 Spitz-Kupferstück**

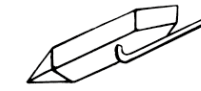

Stücke à	250 g	350 g	500 g
p. St.	17.40	19.00	25.90

**SPENGLER Spezial-Spitz-Kupferstück**

schnell heiss, keine Zunderablagerung, geringerer Zinnverbrauch, kein Nachfeilen



Stücke à	300 g
p. St.	75.60

**903-21 / 22 Hammer-Kupferstück**

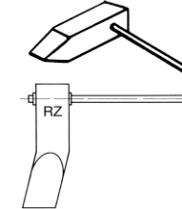

Stücke à	250 g	350 g	500 g
gerade Nr. 903-21 p. St.	17.40	19.00	25.90
gekröpft Nr. 903-22	19.50	26.00	

**903-21 Spezial-Hammer-Kupferstück**

schnell heiss, keine Zunderablagerung, geringerer Zinnverbrauch, kein Nachfeilen



Stücke à	300 g	500 g
p. St.	75.60	88.80

**903-26 Windschutzblech für alle Kupferstücke**

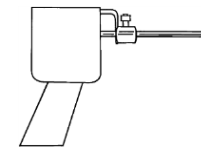

p. St.	8.80
--------	------

**903-30 BERO-Salmiakstein**



mit Dose p. St.	220 g	5.50
ohne Dose	65 x 45 x 20 mm	1.90

**903-31 ZINNFIX Zinn-Salmiakstein**



mit Dose p. St.	150 g	14.50
	Ø 75 x 20 mm	

2019 / 11



**903-35 Deca-Quarz Lötwasser VM-Zink**

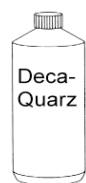

250 ml

p. St. für VM-Zink, Quarz-Zink, Anthra-Zink 39.50

**903-36 Cuirazinc**



1 lt.

p. St. Spezialfarbe für Löt Nähte VM Anthra 46.50

**903-37 SPENGLER UNIGEL**



320 ml

p. St. für Kupfer und Zink 12.00

**903-38 AGROFIX Weichlöt-Flussmittel**



320 ml

p. St. für altes, oxydiertes oder vorbew. Zink 18.50

**903-39 BEROGEN FLUX 100**

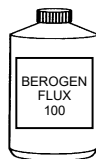

Bidon à 0.75 lt.

p. St. für Uginox 24.50

2019 / 11



**903-40 ROXOIL PLUS Lötöl**



Bidon à

1 lt.

p. St. für Cr-Ni-Stahl, Matt+ RI-Pearl 27.50

**903-41 Lötwasser VA-NOX**

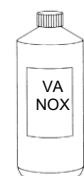

Bidon à

1 kg

p. St. für Cr-Ni-Stahl 4301/4401, Matt+ RI-Pearl 17.00

**903-42 Lötwasser Ferrinox**



Bidon à

1 lt.

p. St. für Cr-Ni-Stahl 4301/4401, Uginox 28.50

**903-45 Lötwasser BERIN 150**



Bidon à

1 lt.

p. St. für Kupfer, Stahlbleche 17.50

**903-49 Lötwasser Steesol**



Bidon à

1 lt.

p. St. für Kupfer, Zink, verzinkte Bleche 42.50

**903-50 Lötwasser FLUX S-39**



Bidon à

0.75 lt.

p. St. für Kupfer 22.00

2019 / 11





**903-51 BERIN-STANNEX-Lötwasser**



	Bidon à	1 lt.
p. St.	für Zink, verzinkte und verzinnete Bleche	22.50

**903-55 Lötwasser Z-04 / Z-04 S / ZD-pro**

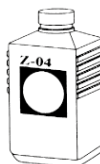

	Bidon à	0.75 lt.
Z-04	p. St.	für Zink 12.00
Z-04 S		für Zink vorbewittert 12.00
ZD-pro		für RZ / RZ vorbewittert 14.00

**903-56 Lötwasser Z-02**

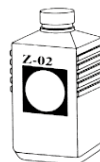

	Bidon à	0.75 lt.
p. St.	für Kupfer, verzinnertes Blech	13.00

**903-57 ROVISTA N**



	Bidon à	0.75 lt.
p. St.	für Zink, Zink vorbewittert, Kupfer	17.90

**903-59 Lötnahtreiniger**



		500 ml	1000 ml
Sprühflasche	p. St.	für Kupfer, Zink, Edelstahl, verzinkt, Blei 25.20	-
Nachfüllflasche	p. St.	-	37.80

2019 / 11



**903-60 Lötwasser-Pinsel**

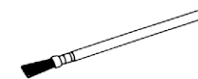

Blech	p. St.	0.60
Kunststoff		0.90

**903-64 Lötwasser-Behälter**



	Inhalt	150 ml
Kunststoff blau	p. St.	ca. 65 x 65 mm 6.00
Kunststoff gelb		6.00
Kunststoff transparent		8.00
mit Auslaufschutz (903-67) nur Transparent		+ 5.00

**903-65 Lötwasser-Behälter, 2-teilig**



p. St.	18.00
--------	-------

**903-67 Lötwasser-Behälter mit Pinsel und Auslaufschutz**



	Inhalt	150 ml
Kunststoff blau	p. St.	13.00
Kunststoff gelb		13.00

**903-68 Lötwasser-Flasche mit Pinsel**



	Inhalt	250 ml
p. St.		19.00

**903-69 SPENGLER Lötwasser-Flasche**



	Inhalt	200 ml
p. St.	Grundfläche 100 x 100 mm	9.50

2019 / 11



**903-90 Sweeper / ROTOL**



Flaschen à 1 lt.

Oberflächen-Schutzmittel für Metalle!	p. St.	Finish- und Reinigungsöl	18.00
---------------------------------------	--------	--------------------------	-------

**903-91 PUNKTOL**



Bidon à 1 lt. 5 lt.

	p. St.	19.90	79.50
--	--------	-------	-------

**903-92 Kupfer-Brünierungsmittel, zum braun Oxydieren von Kupferblechen**



Verpackungseinheit 4 Flaschen à 1 lt.

	p. St.	45.00
--	--------	-------

**903-95 Ferrox Reinigungspaste**

Gift- und säurefrei, biologisch abbaubar, reinigt, poliert und konserviert



Dosen à 500 g

	p. St.	für Edelstahl, Kupfer, Alu	48.00
--	--------	----------------------------	-------

**903-96 Edelstahl-Reiniger PELOX 3000**

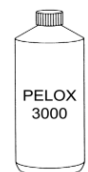

Flaschen à 1 kg

1 kg für 5-10 m² Fläche	p. St.	33.00
-------------------------	--------	-------

2019 / 11



**904-01 BEROGEN 105 / 2AG**

Kupferphosphorlot silberhaltig, für Verbindung Kupfer / Kupfer speziell für Baubleche  
Solidus / Liquidus 710° C, Zugfestigkeit 40 kg/mm²

in Paketen à 1 kg Ø 2 mm

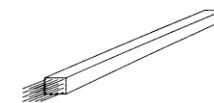

	p. Pk.	*
--	--------	---

**904-19 BEROGEN 608 F / 8034 F**

Silberlot, hochsilberhaltig, mit Flussmittel für Verbindung Kupfer/Kupfer, speziell für dünne Bleche  
Solidus / Liquidus 650° C, Zugfestigkeit 40 kg/mm², Cadmium-frei, 34% Silber

in Paketen à 1 kg Ø 1.5 mm 2 mm

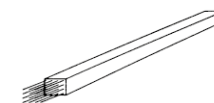

	p. Pk.	*	*
--	--------	---	---

**905-71 Putzlappen Baumwolle**



Stück à 5 kg	p. St.	19.80
--------------	--------	-------

**911-14 Spezial-Entfetter 3M**

Bidon à 5 lt.

	p. St.	75.00
--	--------	-------

**911-26 Reparaturband**

Rollen à 10 m¹ Breite 50 mm 100 mm 150 mm 300 mm

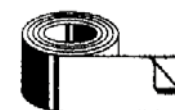

Alu / Bitumen	p. St.	9.90	19.00	28.50	59.00
---------------	--------	------	-------	-------	-------

2019 / 11



**909-61 ENKOLIT**

zum Verkleben und Abdichten von Profilen und Blechen



Verbrauch/m<sup>2</sup> ca. 2 - 3 kg

Eimer à 11 kg	p. St.	(für ca. 4.5 m <sup>2</sup> )	98.75
---------------	--------	-------------------------------	-------



Kartuschen à 310 ml	p. St.		12.50
---------------------	--------	--	-------

**905-16 ENKOCLEAN Bitumen-Löser**

entfernt Öl und Bitumen von Betonflächen, Mauern und Steinböden.  
Macht Bitumen- und Ölflecken sofort wasserlöslich und kann daher auch zur  
Reinigung der Werkzeuge benutzt werden.

1 lt.

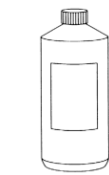

Kunststoffflasche	p. St.		17.50
-------------------	--------	--	-------

2019 / 11



**921-01 Reinigungsgewebe**

zum Reinigen vor dem Schweißen, Löten, Kleben, sehr fein, rotbraun

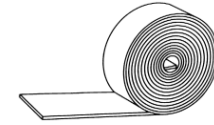

		Breite	100 mm
		Rolle	10 m
CF-RL	p. St.		59.00

**922-01 SCOTCH-BRITE Reinigungsscheibe**

als Aufsatz auf Winkelschleifer



		Ø	115 mm
		U/Min	7000
super fein, grau	p. St.	SFN	4.70

**922-51 Haftteller für Winkelschleifer**



		Ø	115 mm
	p. St.		16.00

**923-01 Reinigungsscheiben, 1 Scheibe mit Dorn**

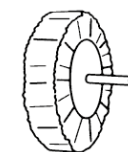

		Ø	75 mm	100 mm	150 mm
		U/Min	5000	3800	2600
13 mm schwarz	p. St.		9.00	11.00	19.00

2019 / 11



**923-21 Reinigungsscheibe ohne Dorn**

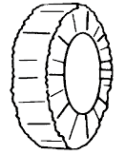

	Ø	100 mm	150 mm
	U/Min	3800	2600
	Schaft Ø	6 mm	8 mm

p. St.	8.60	14.00
--------	------	-------

**924-01 Reinigungsbürste**

zum Abschleifen von Schweiss- und Lötflächen und Reinigen

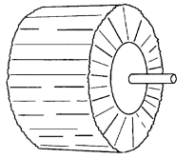

	Ø	60 mm	75 mm	100 mm
	Breite	30 mm	50 mm	45 mm
	U/Min	9500	4000	3200

braun	p. St.	13.50	16.00	26.50
-------	--------	-------	-------	-------

**925-31 SPENGLER Schleifbürsten CONTROL Brush**



	Ø	100 mm	100 mm
Pakete à 5 Stück mit 1 Dorn	Breite	10 mm	21 mm
	U/Min		3500

p. St.	107.50	108.00
--------	--------	--------

**Zusatz Dorn**

p. St.	1.80
--------	------

**965-01 Dichtungsring EPDM für Rohrdurchdringungen**



	Ø	50 - 70 mm	70 - 90 mm	100 mm	105-125 mm
--	---	------------	------------	--------	------------

EPDM schwarz	p. St.	6.15	7.13	7.99	8.10
--------------	--------	------	------	------	------

EPDM grau	p. St.	-	-	-	8.10
-----------	--------	---	---	---	------

2019 / 11



## UNSERE PARTNER



**Plättli Ganz AG**

Simonstrasse 10  
9016 St.Gallen  
Schweiz

T 071 282 85 10  
info@plaettli-ganz.ch  
plaettli-ganz.ch



DAS FAMILIENUNTERNEHMEN MIT TRADITION SEIT 1898

info@plaettli-ganz.ch | plaettli-ganz.ch